

Top Expected Puzzle and Seating Questions for Upcoming Bank Prelims Exams 2021
(English Version)

 **guidely**

Special Bundle PDF Course for SBI Clerk & IBPS RRB PO Mains Exams 2021

Course Duration: **50 days**
No. of Ques: **5000**



- ✓ Language: English & Hindi
- ✓ Purely Based on Exact Exam Level & New Pattern
- ✓ Exact Exam Level Questions
- ✓ Answer key with Video Solution

~~₹799~~

₹399

Buy Now

Grand Bundle PDF Course 2021

Exams Covered:

**SBI Clerk | SBI PO | IBPS RRB PO |
IBPS RRB Clerk | IBPS PO | IBPS Clerk**

Seperate PDF Course for All Major Bank pre + Mains Exams

- Total No. of Ques: **40,000+**
- Question in Bilingual (Eng & Hindi)
- Answers With Detailed **Video Solution**
- Provides you **50 days Study Planner** for each exams
- **Covers All Types** of Questions in Each Topic
- Questions in **Exact Exam Level**
- All Our PDFs are **Downloadable**
- **100% Satisfaction** Assured & It's Worthy for your money
- Download as PDF & also take **Quiz with Timer**

 **guidely**

Grab It Now

Top Expected Puzzle and Seating Questions for Upcoming Bank Prelims Exams 2021 (English Version)

Direction (1-5): Answer the questions based on the information given below.

Ten persons P, Q, R, S, T, U, V, W, X, and Y live on different floors of a ten-story building, where the bottommost floor is 1 and the floor above it is 2 and so on.

T lives on the 4th floor. Three persons live between U and the one who lives on the floor which is adjacent to the floor on which T lives.

The number of persons living above U is one less than the number of persons living below X.

P lives immediately above Y, who doesn't live on an odd-numbered floor. S doesn't live on an even-numbered floor. R lives above V, but not above Q. V doesn't live on an odd-numbered floor. X lives above W, but not above S, who lives below the 7th floor.

1. How many persons live between the floors on which S and U live?

- A.Three
- B.More than three
- C.Two
- D.None
- E.One

2. Which of the following is true with respect to V?

- A.P lives immediately above V
- B.Only three persons live between V and R
- C.V lives immediately below X
- D.Both (a) and (b)

E.Both (b) and (c)

3. On which floor number does R live?

- A.2nd
- B.4th
- C.8th
- D.6th
- E.None of these

4. Which of the following person lives two floors above X?

- A.The one who lives immediately below P
- B.The one who lives immediately above T
- C.The one who lives immediately above Y
- D.W
- E.None of these

5. Which among the following doesn't form a group?

- A.The one who lives two floors above P
- B.The one who lives immediately below Y
- C.The one who lives immediately above P
- D.The one who lives two floors below U
- E.The one who lives immediately above V

Explanation

Top Expected Puzzle and Seating Questions for Upcoming Bank Prelims Exams 2021 (English Version)

Floors	Persons
10	Q
9	U
8	R
7	P
6	Y
5	S
4	T
3	X
2	V
1	W

- T lives on the 4th
- Three persons live between U and the one who lives on the floor which is adjacent to the floor on which T lives.
- The number of persons living above U is one less than the number of persons is living below X.

	Case 1	Case 2
Floors	Persons	Persons
10		
9	U	
8		
7		U
6		
5		X
4	T	T
3	X	
2		
1		

- P lives immediately above Y, who doesn't live on an odd-numbered floor.
- S doesn't live on an even-numbered floor.
- R lives above V, but not above Q.
- V doesn't live on an odd-numbered floor.

	Case 1	Case 2a	Case 2b
Floors	Persons	Persons	Persons
10	Q	Q	Q
9	U	P	S/W
8	R	Y	R
7	P	U	U
6	Y	R	V
5	S/W	X	X
4	T	T	T
3	X	S/W	P
2	V	V	Y
1	S/W	S/W	S/W

- X lives above W, but not above S, who lives below the 7th
- So the final arrangement becomes:

	Case 1	Case 2a	Case 2b
Floors	Persons	Persons	Persons
10	Q	Q	Q
9	U	P	S/W
8	R	Y	R
7	P	U	U
6	Y	R	V
5	S	X	X
4	T	T	T
3	X	S/W	P
2	V	V	Y
1	W	S/W	S/W

1) Answer: A

Top Expected Puzzle and Seating Questions for Upcoming Bank Prelims Exams 2021 (English Version)

2) Answer: C

3) Answer: C

4) Answer: B

5) Answer: C

Direction (6-10): Answer the questions based on the information given below.

Eight persons viz. P, Q, R, S, T, U, V and W are living in an eight storey building, but not necessarily in the same order. The lowermost floor is numbered 1 and the floor immediately above is numbered 2 and so on. Not more than one person lives on the same floor.

Q lives on an odd numbered floor below the sixth floor but not on the bottommost floor. Only two persons live between Q and P, who lives above Q. The number of floors between Q and P is one more than the number of floors between Q and S who doesn't live adjacent to P. There is only one person living between P and T who lives immediately below V. Not more than two persons live between U and R who lives immediately below W.

6. Four of the following five are alike in a certain way and hence form a group. Find the one that doesn't belong to that group.

A.W

B.T

C.U

D.P

E.V

7. In which of the following floor does R live?

A.4th

B.5th

C.1st

D.7th

E.8th

8. How many persons live between T and W?

A.One

B.Three

C.Two

D.More than three

E.None

9. If all the persons are arranged in alphabetical order from top to bottom, then how many persons remain unchanged in their positions?

A.One

B.Two

C.Three

D.More than three

E.None

10. If P is related to T in the same way Q is related to S, then U is related to _____?

A.T

B.Q

C.S

D.W

E.R

Explanation

Top Expected Puzzle and Seating Questions for Upcoming Bank Prelims Exams 2021 (English Version)

Floor	Persons
8	P
7	V
6	T
5	Q
4	U
3	S
2	W
1	R

1. Q lives on an odd numbered floor below sixth floor but not on the bottommost floor. Only two persons live between Q and P, who lives above Q.

	Case 1	Case 2
Floor	Persons	Persons
8	P	
7		
6		P
5	Q	
4		
3		Q
2		
1		

2. The number of floors between Q and P is one more than the number of floors between Q and S who doesn't live adjacent to P. There is only one person living between P and T who lives immediately below V.

	Case 1	Case 2
Floor	Persons	Persons
8	P	
7	V	
6	T	P
5	Q	V
4		T
3	S	Q
2		
1		S

3. Not more than two persons live between U and R who lives immediately below W. Hence, case 2 gets eliminated.

	Case 1	Case 2
Floor	Persons	Persons
8	P	
7	V	
6	T	P
5	Q	V
4	U	T
3	S	Q
2	W	
1	R	S

- 6) Answer: E
 7) Answer: C
 8) Answer: B
 9) Answer: A
 10) Answer: D

Top Expected Puzzle and Seating Questions for Upcoming Bank Prelims Exams 2021 (English Version)

Direction (11-15): Study the following information carefully and answer the question below.

Eight persons I, K, L, M, N, O, P and T lives in a four story building. Each floor has two flats which is flat 1 and flat 2. No two persons live in the same flat. Flat 1 is in West of flat 2.

One person lives between N and T and both N and T's flat numbers are same. M and P live on the same floor. L lives immediately below P in the same flat. L doesn't live on the bottom-most floor. K doesn't live in the same flat as O lives. There is a gap of at most one floor between O and I. I lives above N. No one lives to the West of K. K doesn't live below O.

11. Who among the following lives in Flat 1 of 3rd-floor?

- A. T
- B. L
- C. P
- D. N
- E. K

12. How many persons live below I (including both flats)?

- A. 3
- B. 4
- C. 1
- D. 2
- E. None of these

13. Who among the following lives to the east of N?

- A. L
- B. O
- C. I
- D. M
- E. None of these

14. Number of persons live above P is the same as number of persons live below ___?

- A. N
- B. I
- C. K
- D. T
- E. L

15. Who among the following lives in same flats?

- A. T and I
- B. K and P
- C. M and O
- D. L and N
- E. L and O

Explanation

Flat Floor	Flat 1	Flat 2
4	M	P
3	T	L
2	K	I
1	N	O

Top Expected Puzzle and Seating Questions for Upcoming Bank Prelims Exams 2021 (English Version)

One person lives between N and T and both N and T's flat numbers are same. Here we get four possibilities

	Case (1)		Case (2)		Case (3)		Case (4)	
Flat Floor	Flat 1	Flat 2	Flat 1	Flat 2	Flat 1	Flat 2	Flat 1	Flat 2
4	N/T			N/T				
3					N/T			N/T
2	T/N			T/N				
1					T/N			T/N

M and P live on the same floor. L lives immediately below P in the same flat. L does not live on the bottom-most floor.

	Case (1)		Case (2)		Case (3)		Case (4)	
Flat Floor	Flat 1	Flat 2	Flat 1	Flat 2	Flat 1	Flat 2	Flat 1	Flat 2
4	N/T			N/T	M	P	P	M
3	M	P	P	M	N/T	L	L	N/T
2	T/N	L	L	T/N				
1					T/N			T/N

Atmost one floor gap between O's floor and I's floor. No one lives to the west of K. K doesn't live below O.

	Case (1)		Case (2)		Case (3)		Case (4)	
Flat Floor	Flat 1	Flat 2	Flat 1	Flat 2	Flat 1	Flat 2	Flat 1	Flat 2
4	N/T		K	N/T	M	P	P	M
3	M	P	P	M	N/T	L	L	N/T
2	T/N	L	L	T/N	K	I/O	K	O/I
1	K		O/I	I/O	T/N	O/I	I/O	T/N

We cannot fix the position of I and O in case (1). So this case is eliminated.

K does not live in the same flat as O lives. I lives above N.

	Case (2)		Case (3)		Case (4)	
Flat Floor	Flat 1	Flat 2	Flat 1	Flat 2	Flat 1	Flat 2
4	K	N/T	M	P	P	M
3	P	M	T	L	L	T
2	L	T/N	K	I	K	I
1	O/I	I/O	N	O	O	N

We cannot fix the position of I above N in case (2) and position of O in case (4). So these cases are eliminated.

11) Answer: A

12) Answer: D

13) Answer: B

14) Answer: A

15) Answer: E

Direction (16-20): Study the following information carefully and answer the questions given below:

Eight persons P, Q, R, S, T, U, V, and W are living in two different flats i.e. flat A and flat B of a four storey building such that the lower most floor is numbered as 1, floor immediate above it is numbered as 2 and so on but not necessarily in the same order. Flat A is in the west of flat B. All the persons like different fruits namely- Guava, Papaya, Mango, Apple, Watermelon, Grapes, Banana and orange but not necessarily in the same order.

The one who likes orange lives to the west of the one who likes banana which is liked by S. There are two floors between the one who likes grapes and Banana. The one who likes grapes lives in flat B. P lives just above T's flat. The one

Top Expected Puzzle and Seating Questions for Upcoming Bank Prelims Exams 2021 (English Version)

who likes Guava lives two floors above the one who likes papaya and both are living in the same flat of P. Those who like Mango and Papaya live on the same floor. Only One floor is between N and U, who likes papaya. Both W and Q live in the same flats but none of them likes watermelon. Q does not live on an even numbered floor.

16. The one who likes watermelon lives just above to ____ and both live in the same flat?

- A.The one who likes Orange
- B.None of these
- C.The one who likes Guava
- D.The one who likes Grapes
- E.U

17. Who lives in the flat which is just below to Q's flat?

- A.None of these
- B.The one who likes Orange
- C.The one who likes Watermelon
- D.The one who likes banana
- E.The one who likes Mango

18. Which of following statements is/are true regarding R?

- I). R likes Watermelon
- II). R lives on second floor
- III). R lives in flat B
- IV). R likes Guava
- A.Both I and II
- B.Only IV
- C.Only III

- D.None is true
- E.Only II

19. Four of the following five are alike in a certain way thus forms a group. Find the one which does not belong to the group?

- A.P- Grapes
- B.N- Papaya
- C.U – Mango
- D.R- Banana
- E.Apple- T

Except (e), in all options both persons are living on the same floor.

20. Who among the following persons is/ are living in Flat A?

- I). P
- II). Q
- III). W
- IV). U
- A.Both I and II
- B.Both II and III
- C.All I, II and III
- D.Both III and IV
- E.Both I and IV

Explanation

	Case-II	
Floors	Flat-A	Flat-B
4	P, Guava	N, Grapes
3	T, Watermelon	Q, Apple
2	U, Papaya	W, Mango
1	R, Orange	S, Banana

We have,

Top Expected Puzzle and Seating Questions for Upcoming Bank Prelims Exams 2021 (English Version)

- The one who likes orange lives to the west of the one who likes banana which is liked by S.
- There are two floors between the one who likes banana and grapes. The one who likes grapes lives in flat B.

Floors	Case-I		Case-II	
	Flat-A	Flat-B	Flat-A	Flat-B
4	Orange	S, Banana		Grapes
3				
2				
1		Grapes	Orange	S, Banana

Again we have,

- The one who likes Guava lives two floors above the one who likes papaya and both are living in same flat of P.
- Those who like Mango and Papaya live on the same floor. Only One floor is between N and U, who likes papaya.
- P lives just above T's flat.

Floors	Case-I		Case-II	
	Flat-A	Flat-B	Flat-A	Flat-B
4	Orange	S, Banana	P, Guava	N, Grapes
3	Guava		T,	
2			U, Papaya	Mango
1	Papaya	Grapes	Orange	S, Banana

Case-I gets eliminated because those who likes papaya and mango must live on same floor.

Again we have,

- W and Q live in the same flats but none of them likes watermelon.
- Q does not live on an even numbered floor.

Floors	Case-II	
	Flat-A	Flat-B
4	P, Guava	N, Grapes
3	T, Watermelon	Q, Apple
2	U, Papaya	W, Mango
1	R, Orange	S, Banana

16) Answer: E

17) Answer: E

18) Answer: D

19) Answer: B

20) Answer: E

Direction (21-25): Answer the questions based on the information given below.

Six boxes were filled with different chocolates viz. Barone, Dairy milk, Kitkat, Milky bar, Munch and Perk. Each box has some number of chocolates viz. 12, 16, 20, 24, 28 and 32. All the information is not necessarily in the same order. The lowermost box is numbered 1 and the box above is numbered 2 and so on.

Only two boxes were placed between the box with 16 chocolates and Barone where neither of them is placed at the topmost or bottommost positions. Munch was placed in the box immediately above the box with 16 chocolates. Only two boxes are there between Munch and Milky bar which has 12 chocolates. The lowermost box has 20 chocolates which is 12 less than the number of chocolates in box 4. The box with Dairy milk has neither 20 nor 32 chocolates. The box with Kitkat has more

Top Expected Puzzle and Seating Questions for Upcoming Bank Prelims Exams 2021 (English Version)

number of chocolates than Perk. The box with Munch has less number of chocolates than Barone but not kept below Barone.

21. The box with Dairy milk was placed at which of the following position?

- A.3
- B.2
- C.5
- D.4
- E.None of these

22. Which of the following chocolate was placed in box 2?

- A.Milky bar
- B.Barone
- C.Kitkat
- D.Perk
- E.None of these

23. How many boxes are placed between the box with 28 chocolates and Kitkat?

- A.1
- B.2
- C.3
- D.None
- E.Cannot be determined

24. How many chocolates are there in the box with Perk?

- A.16
- B.28
- C.32

D.20

E.Cannot be determined

25. Which of the following chocolate has 24 in the box?

- A.Barone
- B.Perk
- C.Milky bar
- D.Munch
- E.Kitkat

Explanation

Box	Chocolate	Count
6	Munch	24
5	Dairy milk	16
4	Kitkat	32
3	Milky bar	12
2	Barone	28
1	Perk	20

1. Only two boxes are placed between the box with 16 chocolates and Barone where neither of them is placed at the topmost or bottommost positions.

2. Munch was placed in the box immediately above the box with 16 chocolates.

Box	Case 1		Case 2	
	Chocolate	Count	Chocolate	Count
6	Munch			
5		16	Barone	
4				
3			Munch	
2	Barone			16
1				

Top Expected Puzzle and Seating Questions for Upcoming Bank Prelims Exams 2021 (English Version)

3. Only two boxes are there between Munch and Milky bar which has 12 chocolates.

4. The lowermost box has 20 chocolates which is 12 less than the number of chocolates in box

4.

	Case 1		Case 2	
Box	Chocolate	Count	Chocolate	Count
6	Munch		Milky bar	12
5		16	Barone	
4		32		32
3	Milky bar	12	Munch	
2	Barone			16
1		20		20

5. The box with Dairy milk has neither 20 nor 32 chocolates.

6. The box with Kitkat has more number of chocolates than Perk.

	Case 1		Case 2	
Box	Chocolate	Count	Chocolate	Count
6	Munch		Milky bar	12
5	Dairy milk	16	Barone	
4	Kitkat	32	Kitkat	32
3	Milky bar	12	Munch	
2	Barone		Dairy milk	16
1	Perk	20	Perk	20

7. The box with Munch has less number of chocolates than Barone but not kept below Barone. Hence, case 2 gets eliminated.

	Case 1		Case 2	
Box	Chocolate	Count	Chocolate	Count
6	Munch	24	Milky bar	12
5	Dairy milk	16	Barone	28
4	Kitkat	32	Kitkat	32
3	Milky bar	12	Munch	24
2	Barone	28	Dairy milk	16
1	Perk	20	Perk	20

21) Answer: C

22) Answer: B

23) Answer: A

24) Answer: D

25) Answer: D

Direction (26-30): Answer the questions based on the information given below.

Eight food items viz. Biscuit, Brownie, Cake, Chocolate, Fries, Ice cream, Milk shake and Salad are placed in eight boxes, but not necessarily in the same order. The lowermost box is numbered as 1 and the box above it is numbered as 2 and so on till the topmost box is numbered as 8. Not more than one item was placed in the same box.

Salad was placed in an even numbered box and three boxes above the box with Biscuit. Only one box was placed between the boxes with Biscuit and Fries which was not placed immediately below the box with Salad. Less than two boxes were placed below the box with Chocolate. Cake was placed in an odd numbered box immediately above the box with Milk shake. Ice cream was neither placed in an even numbered box nor at the bottom most position.

26. Which of the following item is placed at the topmost position?

A. Salad

B. Ice cream

C. Brownie

D. Cake

E. None of these

Top Expected Puzzle and Seating Questions for Upcoming Bank Prelims Exams 2021 (English Version)

27. How many boxes are there between the boxes with Salad and Chocolate?

- A. None
- B. One
- C. Two
- D. Three
- E. More than three

28. What is the number of the box with Milk shake?

- A. 6
- B. 4
- C. 2
- D. 5
- E. None of these

29. Which of the following item was placed three boxes above the box with Chocolate?

- A. Cake
- B. Salad
- C. Fries
- D. Ice cream
- E. None of these

30. The number of boxes above the box with Biscuit is one less than the number of boxes below the box with _____.

- A. Fries
- B. Brownie
- C. Salad
- D. Cake
- E. Ice cream

Explanation

Box	Item
8	Brownie
7	Ice cream
6	Salad
5	Cake
4	Milk shake
3	Biscuit
2	Chocolate
1	Fries

1. Salad was placed in an even numbered box and three boxes above the box with Biscuit. Only one box was placed between the boxes with Biscuit and Fries which was not placed immediately below the box with Salad.

	Case 1	Case 2
Box	Item	Item
8	Salad	
7		
6		Salad
5	Biscuit	
4		
3	Fries	Biscuit
2		
1		Fries

2. Less than two boxes were placed below the box with Chocolate. Cake was placed in an odd numbered box immediately above the box with Milk shake.

Top Expected Puzzle and Seating Questions for Upcoming Bank Prelims Exams 2021 (English Version)

	Case 1	Case 1a	Case 2
Box	Item	Item	Item
8	Salad	Salad	
7	Cake	Cake	
6	Milk shake	Milk shake	Salad
5	Biscuit	Biscuit	Cake
4			Milk shake
3	Fries	Fries	Biscuit
2	Chocolate		Chocolate
1		Chocolate	Fries

3. Ice cream was neither placed in an even numbered box nor at the bottom most position. Hence, cases 1 and 1a gets eliminated.

	Case 1	Case 1a	Case 2
Box	Item	Item	Item
8	Salad	Salad	Brownie
7	Cake	Cake	Ice cream
6	Milk shake	Milk shake	Salad
5	Biscuit	Biscuit	Cake
4			Milk shake
3	Fries	Fries	Biscuit
2	Chocolate		Chocolate
1		Chocolate	Fries

26) Answer: C

27) Answer: D

28) Answer: B

29) Answer: A

30) Answer: E

Direction (31-35): Answer the questions based on the information given below.

Nine boxes viz. A, B, C, D, E, F, G, H and I were placed one above the other in the single stack,

but not necessarily in the same order. The lowermost box is numbered 1 and the box above is numbered 2 and so on. The consecutive alphabetically named boxes were not placed adjacent to each other.

Box I was placed in a prime numbered position and two boxes above box H. The number of boxes above box H is the same as the number of boxes below box A which was placed immediately above box E. Only three boxes were placed between the boxes E and D which was placed two boxes below box B. Box C was placed immediately above box G.

31. Which of the following box was placed at the bottommost position?

- A.G
- B.F
- C.H
- D.B
- E.D

32. What is the position of box B from the bottom?

- A.6
- B.2
- C.3
- D.4
- E.None of these

33. How many boxes are there between the boxes A and D?

- A.3

Top Expected Puzzle and Seating Questions for Upcoming Bank Prelims Exams 2021 (English Version)

- B.5
- C.2
- D.7
- E.None of these

34. What is the position of the box G with respect to the box I?

- A.Three boxes above
- B.Immediately below
- C.Two boxes above
- D.Four boxes below
- E.None of these

35. Which of the following box is placed at position 6?

- A.C
- B.G
- C.E
- D.B
- E.None of these

Explanation

Box	Name
9	C
8	G
7	A
6	E
5	I
4	B
3	H
2	D
1	F

1. Box I was placed in a prime numbered position and two boxes above box H. The number of boxes above box H is the same as the number of boxes below box A which was placed immediately above box E.

	Case 1	Case 2
Box	Name	Name
9		A
8		E
7	A	
6	E	
5	I	
4		
3	H	I
2		
1		H

2. Only three boxes were placed between the boxes E and D which was placed two boxes below box B. Box C was placed immediately above box G. Hence, case 2 gets eliminated.

Top Expected Puzzle and Seating Questions for Upcoming Bank Prelims Exams 2021 (English Version)

	Case 1	Case 2
Box	Name	Name
9	C	A
8	G	E
7	A	
6	E	B
5	I	
4	B	D
3	H	I
2	D	
1	F	H

31) Answer: B

32) Answer: D

33) Answer: E

34) Answer: A

35) Answer: C

Direction (36-40): Answer the questions based on the information given below.

Twelve boxes are kept in two stacks viz. Stack 1 and Stack 2. Each stack contains six boxes. Box number 1 is the bottommost box and box number 6 is the topmost box. Box numbered 1 of stack 1 placed west of the box numbered 1 of stack 2. Box I is not the topmost box.

Box G is the 5th number box. Box D is kept just below G, both are kept in different stacks. Box A is kept northwest of box B, both are doesn't keep in an even-numbered box. Not more than two shelves between A and B. Box C is the topmost box. Box number of box E and box L is the same, but not odd-numbered. Box I is kept

northeast of box K, which is kept above box A. Box H is kept below box F, but not below box J, which is kept southwest of both F and H. Box I and box L are kept in the same stack, but not with box G.

36. How many boxes are kept above the box K?

- A. Four
- B. None
- C. Two
- D. Six
- E. None of these

37. Which among the following pair of boxes kept on the bottommost position?

- A. J, H
- B. E, L
- C. J, B
- D. A, D
- E. None of these

38. Which among the following box is box numbered 3 of stack 2?

- A. A
- B. H
- C. D
- D. G
- E. None of these

39. Which among the following doesn't form a group?

- A. G, D
- B. A, L

Top Expected Puzzle and Seating Questions for Upcoming Bank Prelims Exams 2021 (English Version)

C.E, B
D.J, L
E.K, H

40. Which among the following is true with respect to box H?

- A.Box Fis kept immediately above box H
- B.Box Ais kept east of box H
- C.Box H is the 4th numbered box
- D.Only one box kept between box H and box I in the same stack
- E.None is true

Explanation

Case 1		
Box No.	Stack 1	Stack 2
6	C	F
5	G	I
4	K	D
3	A	H
2	E	L
1	J	B

- Box G is the 5th number box.
- Box D is kept just below G, both are kept in different stacks.

	Case 1		Case 2	
Box No.	Stack 1	Stack 2	Stack 1	Stack 2
6				
5	G			G
4		D	D	
3				
2				
1				

- Box A is kept northwest of box B, both are doesn't keep in an even-numbered box.
- Not more than two shelves between A and B.
- Box C is the topmost box.
- Box number of box E and box L is the same, but not odd-numbered.
- Box I is kept northeast of box K, which is kept above box A.
- Box I is not the topmost box.

	Case 1		Case 2a		Case 2b	
Box No.	Stack 1	Stack 2	Stack 1	Stack 2	Stack 1	Stack 2
6	C/	C/	C	I	C/	C/
5	G	I	K	G	A	G
4	K	D	D		D	
3	A		A			B
2	E/L	E/L	E/L	E/L	E/L	E/L
1		B		B		

- Box H is kept below box F, but not below box J, which is kept southwest of both F and H.
- Box I and box L are kept in the same stack, but not with box G.
- So the final arrangement becomes:

Top Expected Puzzle and Seating Questions for Upcoming Bank Prelims Exams 2021 (English Version)

Case 1		
Box No.	Stack 1	Stack 2
6	C	F
5	G	I
4	K	D
3	A	H
2	E	L
1	J	B

36) Answer: A

37) Answer: C

38) Answer: B

39) Answer: D

40) Answer: D

Direction (41-45): Study the following information carefully and answer the questions given below.

Eight people A, B, C, D, E, F, G, and H were born in different months from January to August but not necessarily in the same order.

A was born in the month having an even number of days. Three persons were born between A and E. A was not born in February. C was born immediately before G, who was born after A. At least one person was born between E and G. H was born immediately before D and was born immediately after B. H was born in the month having less than 30 days.

41. Who was born in January?

A.B

B.A

C.H

D.C

E.None of these

42. How many persons were born between A and E?

A.One

B.Two

C.Three

D.Four

E.None of these

43. If the persons are arranged in alphabetical order from January to August, then how many persons remain in the same position?

A.One

B.Two

C.Three

D.Four

E.No one

44. Four of the following five are alike in a certain way and thus form a group as per the given arrangement. Which of the following does not belong to that group?

A.The one who was born on January

B.H

C.E

D.The one who was born on July

E.D

45. If B is related to E and A is related to C in a certain way, then who is related to F?

Top Expected Puzzle and Seating Questions for Upcoming Bank Prelims Exams 2021 (English Version)

- A.H
 B.The one who was born on April
 C.The one who was born on march
 D.The one who was born on February
 E.Both A & D

Explanation

Month	Persons
January	B
February	H
March	D
April	A
May	C
June	G
July	F
August	E

We have,

- A was born in the month having an even number of days.
- Three persons were born between A and E.
- A was not born in February.

	Case 1	Case 2
Month	Persons	Persons
January		
February		E
March		
April	A	
May		
June		A
July		
August	E	

Again we have,

- C was born immediately before G, who was born after A.
- At least one person was born between E and G.

	Case 1	Case 2
Month	Persons	Persons
January		
February		E
March		
April	A	
May	C	
June	G	A
July		C
August	E	G

Again we have,

- H was born immediately before D and was born immediately after B.
- H was born in the month having less than 30 days.

	Case 1	Case 2
Month	Persons	Persons
January	B	
February	H	E
March	D	
April	A	
May	C	
June	G	A
July	F	C
August	E	G

41) Answer: A

Top Expected Puzzle and Seating Questions for Upcoming Bank Prelims Exams 2021 (English Version)

42) Answer: C

43) Answer: E

44) Answer: B

45) Answer: E

Direction (46-50): Study the following information carefully and answer the below questions

Six persons- Sam, Raj, Anu, Ani, Ben and Ram are bought the different brand sports shoes- Puma, Reebok, Aero, Adidas, Nike and Metro on different months- January, March, May, June, September and October but not necessarily in the same order.

Ani bought Nike brand in June. The person who bought the Reebok brand bought immediately before Anu. Ram does not buy after Ben. Sam bought two months before Raj (for example if sam bought in February then Raj bought in April). Two persons bought between Ani and the one who bought Puma. Neither Anu nor Raj bought Aero. Ram bought the metro brand shoe.

46. Which of the following combination is true?

A. Sam-Reebok

B. Anu-Nike

C. Raj- Puma

D. September- Adidas

E. October- Ben

47. How many persons bought between Raj and The one who bought Aero brand shoe?

A. One

B. Two

C. Four

D. Three

E. Either b or d

48. Who among the following person bought Puma brand?

A. Ben

B. The one who bought immediately before Anu

C. Ram

D. The one who bought in January

E. Ani

49. If Raj is related to May and Ani is related to September in a certain way. Then who among the following is related to October?

A. None of these

B. The one who bought Nike

C. Sam

D. The one who bought Reebok

E. Ram

50. Who among the following person bought in May?

A. Raj

B. Sam

C. The one who bought the Adidas brand

D. The one who bought Metro

E. Ben

Top Expected Puzzle and Seating Questions for Upcoming Bank Prelims Exams 2021 (English Version)

Explanation

	Person	Brand
January	Sam	Puma
March	Raj	Reebok
May	Anu	Adidas
June	Ani	Nike
September	Ram	Metro
October	Ben	Aero

Ani bought Nike brand in June.

Two persons bought between Ani and the one who bought Puma.

The person who bought the Reebok brand bought immediately before Anu.

From the above condition, there are two possibilities.

	Case1		Case2	
	Person	Brand	Person	Brand
January		Puma		Puma
March		Reebok		
May	Anu			
June	Ani	Nike	Ani	Nike
September				Reebok
October			Anu	

Sam bought two months before Raj.

From the above condition, there are three possibilities.

	Case1		Case2		Case2a	
	Person	Brand	Person	Brand	Person	Brand
January	Sam	Puma	Sam	Puma		Puma
March	Raj	Reebok	Raj		Sam	
May	Anu				Raj	
June	Ani	Nike	Ani	Nike	Ani	Nike
September				Reebok		Reebok
October			Anu		Anu	

Neither Anu nor Raj bought Aero.

Ram bought the metro brand shoe.

Ram does not buy after Ben.

From the above condition, case2 and case2a get eliminated. Case1 shows the final arrangement.

	Case1		Case2		Case2a	
	Person	Brand	Person	Brand	Person	Brand
January	Sam	Puma	Sam	Puma		Puma
March	Raj	Reebok	Raj		Sam	
May	Anu	Adidas	Ram	Metro	Raj	
June	Ani	Nike	Ani	Nike	Ani	Nike
September	Ram	Metro		Reebok		Reebok
October	Ben	Aero	Anu		Anu	

46) Answer: E

47) Answer: D

48) Answer: D

49) Answer: E

50) Answer: C

Top Expected Puzzle and Seating Questions for Upcoming Bank Prelims Exams 2021 (English Version)

Direction (51-55): Study the following information carefully and answer the questions given below.

Seven persons T, U, V, W, X, Y, and Z are going to a movie on different days of the same week from Sunday to Saturday.

Two persons go to a movie between V and X, neither of them goes at first nor at last. Only one person goes between X and W, who doesn't go immediately before V. As many persons go to a movie between T and W as the persons who go to a movie between T and Z. Y go to a movie neither on Monday and Friday nor before U.

51. Who among the following person goes on Monday?

- A.W
- B.U
- C.T
- D.Y
- E.V

52. How many persons go to a movie between X and Z?

- A.As many persons go to a movie between V and W.
- B.As many persons go to a movie between U and V.
- C.As many persons go to a movie between T and Z.
- D.As many persons go to a movie between W and T.
- E.Both B & D.

53. Four of the following five are alike in a certain way and thus form a group as per the given arrangement. Which of the following does not belong to that group?

- A.ZY
- B.VT
- C.YX
- D.UT
- E.XW

54. If W is related to Z and X is related to Y in a certain manner, then who among the following is related to U?

- A.X
- B.Z
- C.V
- D.Y
- E.No one

55. Who among the following persons goes two days before Y?

- A.U
- B.T
- C.X
- D.W
- E.No one

Explanation

Top Expected Puzzle and Seating Questions for Upcoming Bank Prelims Exams 2021 (English Version)

Days	Persons
Sunday	W
Monday	U
Tuesday	X
Wednesday	T
Thursday	Y
Friday	V
Saturday	Z

We have,

- Two persons go to a movie between V and X, neither of them goes at first nor at last.
- Only one person goes between X and W, who doesn't go immediately before V.
- As many persons go to a movie between T and W as the persons who go to a movie between T and Z.

	Case 1	Case 2
Days	Persons	Persons
Sunday	W	Z
Monday		V
Tuesday	X	
Wednesday	T	T
Thursday		X
Friday	V	
Saturday	Z	W

Again we have,

- Y go to a movie neither on Monday and Friday nor before U. so case-2 is eliminated.

	Case 1	Case 2
Days	Persons	Persons
Sunday	W	Z
Monday	U	V
Tuesday	X	U
Wednesday	T	T
Thursday	Y	X
Friday	V	Y
Saturday	Z	W

51) Answer: B

52) Answer: B

53) Answer: D

54) Answer: C

55) Answer: C

Direction (56-60): Study the following information carefully and answer the questions given below:

Seven friends are distributing blankets on different days from Monday to Sunday.

Everyone is distributing different number of blankets 21, 23, 25, 26, 27, 29 and 31.

Seema distributed least number of blankets and she distributed on Friday.

Meena distributed 23 blankets just before Jaya, who did not distribute on Sunday. Difference between Jaya and Reeta's blankets is 2, but

Top Expected Puzzle and Seating Questions for Upcoming Bank Prelims Exams 2021 (English Version)

none of them distributed highest number of blankets and Reeta is not the first and last to distribute. Pragma distributed after Meena but before Seeta and Maya, who did not distribute at last. The number of blankets distributed on Saturday is multiple of 5, but not by Reeta. The one who distributed on Thursday is distributing even no. of blankets. Sum of the blankets distributed by Reeta and Pragma is 53.

56. What is the sum of blankets distributed by Seeta and Meena?

- A. 48
- B. 52
- C. 49
- D. 54
- E. 47

57. In which of the following days Pragma distributed the blankets?

- A. Tuesday
- B. Friday
- C. Thursday
- D. Friday
- E. Saturday

58. How many persons are distributing blankets between Maya and Reeta?

- A. Three
- B. Four
- C. Two
- D. One
- E. None

59. What is the difference between the number of blankets which are distributed on Tuesday and Sunday?

- A. Four
- B. Three
- C. Two
- D. One
- E. None of the above

60. Which of the following statement is correct?

- A. Pragma distributed on Tuesday
- B. Seema is distributing just after Reeta
- C. Maya has distributed 21 blankets
- D. Seeta has distributed on Sunday
- E. Meena has distributing on Tuesday

Explanation

Final Arrangement:

CASE-III		
Days	Persons	No. of blankets
Monday	Meena	23
Tuesday	Jaya	29
Wednesday	Reeta	27
Thursday	Pragma	26
Friday	Seema	21
Saturday	Maya	25
Sunday	Seeta	31

We have,

- Seema distributed least number of blankets and she distributed on Friday.

Top Expected Puzzle and Seating Questions for Upcoming Bank Prelims Exams 2021 (English Version)

- Meena distributed 23 blankets just before Jaya, who did not distribute on Sunday.
- Difference between Jaya and Reeta's blankets is 2, but none of them distributed highest number of blankets.

Jaya/Reeta- Reeta/Jaya= 2,

So, there can be two cases (25 and 27) and (27,29).

Days	CASE-I		CASE-II		CASE-III	
	Persons	No. of blankets	Persons	No. of blankets	Persons	No. of blankets
Monday					Meena	23
Tuesday			Meena	23	Jaya	
Wednesday	Meena	23	Jaya			
Thursday	Jaya					
Friday	Seema	21	Seema	21	Seema	21
Saturday						
Sunday						

Again, we have

- Reeta is not the first and last to distribute.
- Pragya distributed after Meena but before Seeta and Maya, who did not distribute at last.
- The number of blankets distributed on Saturday is multiple of 5, but not by Reeta.

The one who distributed on Thursday is distributing even number of blankets.

Days	CASE-I		CASE-II		CASE-III	
	Persons	No. of blankets	Persons	No. of blankets	Persons	No. of blankets
Monday			Reeta		Meena	23
Tuesday			Meena	23	Jaya	27/29
Wednesday	Meena	23	Jaya		Reeta	27/29
Thursday	Jaya		Pragya		Pragya	26
Friday	Seema	21	Seema	21	Seema	21
Saturday			Maya	25	Maya	25
Sunday			Seeta		Seeta	31

Case-I gets eliminated because Pragya, Maya and Seeta should distribute blankets after Meena but this is not possible in this case. Case-II gets eliminated because Reeta cannot distribute first or last.

Again, we have

- Sum of the blankets distributed by Reeta and Pragya is 53.

Reeta + 26=53 à Reeta = 53-26=27.

Days	CASE-III	
	Persons	No. of blankets
Monday	Meena	23
Tuesday	Jaya	29
Wednesday	Reeta	27
Thursday	Pragya	26
Friday	Seema	21
Saturday	Maya	25
Sunday	Seeta	31

56) Answer: D

57) Answer: C

58) Answer: C

59) Answer: C

60) Answer: D

Direction (61-65): Study the following information carefully and answer the questions given below:

Seven persons are born on the same day of the same month in seven different years such as 1951, 1954, 1966, 1975, 1978, 1995 and 2005. Their age was calculated based on the year 2020. Each person likes different sports bike

Top Expected Puzzle and Seating Questions for Upcoming Bank Prelims Exams 2021 (English Version)

brands such as BMW, Duke, Ducati, Honda, Kawasaki, Suzuki and Yamaha but not necessarily in the same order.

T's age is multiple of 5. Difference between the ages of T and Q is equal to the age of S who likes Duke. Two persons are born between S and the person who likes BMW. P likes Honda. Two persons are born between R and U who was born before 1975. The person who likes Yamaha age is multiple of 6. The person who likes Suzuki is born after the person who likes Yamaha. The person who likes Kawasaki was born before R. The persons born after the person likes Ducati is equal to the persons born before the person likes Suzuki. Age of V is two less than the difference between the ages of Q and R. R is elder than V.

61. The person who likes Kawasaki was born in _____?

- A. 1951
- B. 1975
- C. 1966
- D. 1954
- E. None of these

62. Who was born in 1978?

- A. The person who likes BMW
- B. The person whose age is 45
- C. The person who likes Duke
- D. The person who likes Yamaha
- E. None of these

63. Which of the following statements is/are true?

- I. Difference between the ages of R and U is 24
 - II. More than two persons born between Q and P
 - III. The person who likes Honda born immediately before R
 - IV. The person who likes BMW is the youngest
- A. Both I and II
 - B. Only I
 - C. None is true
 - D. Only III
 - E. Both I and III

64. Four of the following five are alike in a certain way thus form a group. Find the one which does not belong to the group?

- A. The one who was born two persons before V
- B. Suzuki
- C. Duke
- D. BMW
- E. Honda

65. How many persons are born after the person who likes Honda?

- A. None
- B. One
- C. Two
- D. Three
- E. More than three

Top Expected Puzzle and Seating Questions for Upcoming Bank Prelims Exams 2021 (English Version)

Explanation

Years	Ages	Persons	Brands
1951	69	Q	Ducati
1954	66	U	Kawasaki
1966	54	S	Duke
1975	45	P	Honda
1978	42	R	Yamaha
1995	25	V	BMW
2005	15	T	Suzuki

T's age is multiple of 5. Difference between the ages of T and Q is equal to the age of S who likes Duke.

		Case I	
Years	Ages	Persons	Brands
1951	69	Q	
1954	66		
1966	54	S	Duke
1975	45		
1978	42		
1995	25		
2005	15	T	

Two persons are born between S and the person who likes BMW. The person who likes Yamaha age is multiple of 6.

		Case I		Case II	
Years	Ages	Persons	Brands	Persons	Brands
1951	69	Q		Q	
1954	66		Yamaha		
1966	54	S	Duke	S	Duke
1975	45				
1978	42				Yamaha
1995	25		BMW		BMW
2005	15	T		T	

Age of V is two less than the difference between the ages of Q and R. R is elder than V. Only possible case is R's age is 42 and V's age is 25. Difference between the ages of Q and R is 27 => two more than V's age.

		Case I		Case II	
Years	Ages	Persons	Brands	Persons	Brands
1951	69	Q		Q	
1954	66		Yamaha		
1966	54	S	Duke	S	Duke
1975	45				
1978	42	R		R	Yamaha
1995	25	V	BMW	V	BMW
2005	15	T		T	

Two persons are born between R and U who born before 1975. P likes Honda. The person who likes Suzuki is born after the person who likes Yamaha.

The persons born after the person likes Ducati is equal to the persons born before the person likes Suzuki.

Top Expected Puzzle and Seating Questions for Upcoming Bank Prelims Exams 2021 (English Version)

Years	Ages	Case I		Case II	
		Persons	Brands	Persons	Brands
1951	69	Q	Ducati	Q	Ducati
1954	66	U	Yamaha	U	
1966	54	S	Duke	S	Duke
1975	45	P	Honda	P	Honda
1978	42	R		R	Yamaha
1995	25	V	BMW	V	BMW
2005	15	T	Suzuki	T	Suzuki

The person who likes Kawasaki was born before R.

Years	Ages	Case I		Case II	
		Persons	Brands	Persons	Brands
1951	69	Q	Ducati	Q	Ducati
1954	66	U	Yamaha	U	Kawasaki
1966	54	S	Duke	S	Duke
1975	45	P	Honda	P	Honda
1978	42	R		R	Yamaha
1995	25	V	BMW	V	BMW
2005	15	T	Suzuki	T	Suzuki

61) Answer: D

62) Answer: D

63) Answer: E

64) Answer: C

65) Answer: D

Direction (66-70): Study the following information carefully and answer the below questions.

Eight persons- L, M, N, O, W, X, Y and Z are getting married on different years viz., 2002, 2004, 2005, 2009, 2011, 2012, 2014 and 2017 but not necessarily in the same order.

X gets married on a leap year. Only one person gets married between X and Y. The number of persons getting married before X is same as

after W. Two persons are getting married between M and O. M and O are married in the odd numbered year. L is married immediately before N. O and Y are not married adjacent to each other.

66. Who among the following persons gets married in 2014?

A.M

B.The person who gets married three years after L

C.X

D.The person who gets married immediately before O

E.None of the above

67. Four of the following are alike in a certain way to form the group. Who among the following one does not belong to the group?

A.The person who gets married two persons before W

B.Y

C.The person who gets married immediately after Z

D.The person who gets married immediately after N

E.O

68. How many people got married between L and M?

A.2

B.3

C.4

Top Expected Puzzle and Seating Questions for Upcoming Bank Prelims Exams 2021 (English Version)

D.5

E. None of these

69. As per the given arrangement, L is related to 2004 and N is related to 2005 by following a certain pattern, In the same way, M is related to _____?

A. 2014

B. 2012

C. 2011

D. 2009

E. 2017

70. Which of the following Year does O get married?

A. 2004

B. 2017

C. 2011

D. 2009

E. 2014

Explanation

2002	L
2004	N
2005	W
2009	Y
2011	M
2012	X
2014	Z
2017	O

X gets married on a leap year.

Only one person gets married between X and Y.

From the above condition, there are three possibilities.

	Case-1	Case-2	Case-3
2002			
2004		X	
2005			
2009		Y	Y
2011			
2012	X		X
2014			
2017	Y		

The number of persons getting married before X is same as after W.

Two persons are getting married between M and O.

M and O are married in the odd numbered year.

From the above condition, Case1 gets eliminated.

	Case-1	Case-2	Case-3
2002			
2004		X	
2005	W		W
2009		Y	Y
2011		M/O	M/O
2012	X		X
2014		W	
2017	Y	M/O	M/O

L is married immediately before N.

From the above condition, case2 gets eliminated.

Top Expected Puzzle and Seating Questions for Upcoming Bank Prelims Exams 2021 (English Version)

	Case-2	Case-3
2002		L
2004	X	N
2005		W
2009	Y	Y
2011	M/O	M/O
2012		X
2014	W	
2017	M/O	M/O

O and Y are not married adjacent to each other.

From the above condition, case3 shows the final arrangement.

	Case-3
2002	L
2004	N
2005	W
2009	Y
2011	M
2012	X
2014	Z
2017	O

66) Answer: B

67) Answer: B

68) Answer: B

69) Answer: A

70) Answer: D

Direction (71-75): Study the following information carefully and answer the questions given below:

Ten persons are purchased the cars on 7th and 12th of different months such as June, July, August, September and October.

T purchased on 7th of the month which has 31 days. Three persons purchased between T and V who purchased immediately before Q.

Number of persons purchased after W is one less than the number of persons purchased before Q. Three persons purchased between W and the person who purchased immediately before N. R purchased before S but after O. More than three persons purchased between P and U who purchased after N but not immediately after. Neither W nor O purchased on the same date as P.

71. Who among the following person purchased on 12th August?

- A. Person who purchased on the same month as V
- B. Person who purchased on the same month as U
- C. Person who purchased exactly between T and N
- D. Person who purchased exactly between O and U
- E. Other than the given option

72. How many persons purchased between R and the person purchased on 7th October?

- A. Three
- B. Two
- C. Four

Top Expected Puzzle and Seating Questions for Upcoming Bank Prelims Exams 2021 (English Version)

- D. Five
E. None of these

73. Which of the following statements is/are correct?

- A. Only two persons purchased between T and Q
B. Both R and U purchased on the same date
C. Perfect square number of persons purchased after S
D. Both (a) and (c)
E. All are correct

74. Four of the following five are alike in a certain way thus form a group. Find the one which does not belong to the group?

- A. W-U
B. S-N
C. O-P
D. R-P
E. Q-V

75. Who among the following purchased immediately after the person who purchased on 12th September?

- A. The person who purchased exactly between P and U
B. The person who purchased exactly between N and V
C. The person who purchased exactly between W and S
D. Both (a) and (b)
E. Both (b) and (c)

Explanation

Month	Case-II	
	7 th	12 th
June (30)	V	Q
July (31)	P	O
August (31)	T	R
September (30)	N	S
October (31)	U	W

T purchased on 7th of the month which has 31 days.

Three persons purchased between T and V who purchased immediately before Q.

Month	Case I		Case II		Case III		Case IIa	
	7 th	12 th	7 th	12 th	7 th	12 th	7 th	12 th
June (30)			V	Q				
July (31)	T							
August (31)			T		V	Q	T	
September (30)	V	Q						
October (31)					T		V	Q

Number of persons purchased after W is one less than the number of persons purchased before Q.

Month	Case I		Case II		Case III		Case IIa	
	7 th	12 th	7 th	12 th	7 th	12 th	7 th	12 th
June (30)			V	Q				W
July (31)	T	W						
August (31)			T		V	Q	T	
September (30)	V	Q						
October (31)				W	T		V	Q

Three persons purchased between W and the person who purchased immediately before N.

Top Expected Puzzle and Seating Questions for Upcoming Bank Prelims Exams 2021 (English Version)

Month	Case I		Case II		Case IIa	
	7 th	12 th	7 th	12 th	7 th	12 th
June (30)			V	Q		W
July (31)	T	W				
August (31)			T		T	
September (30)	V	Q	N		N	
October (31)	N			W	V	Q

R purchased before S but after O. More than three persons purchased between P and U who purchased after N but not immediately after. Neither W nor O purchased on the same date as P.

Month	Case I		case II		Case IIa	
	7 th	12 th	7 th	12 th	7 th	12 th
June (30)			V	Q		W
July (31)	T	W	P	O		
August (31)			T	R	T	
September (30)	V	Q	N	S	N	
October (31)	N		U	W	V	Q

71) Answer: C

72) Answer: B

73) Answer: A

74) Answer: D

75) Answer: C

Direction (76-80): Study the following information carefully and answer the below questions.

Eight persons- P, Q, R, S, T, U, V and W are starting their business on different month- March, April, August and November on different dates either 06 or 17 of the month of the year 2020. All the information is not necessarily in the same order.

V has started on April 17. Only one person is starting the business between T and U. W has started two persons before S. T has started the business on even numbered date after V. The number of persons starting between Q and R is same as between U and S. P has started the business on either November or April. S has started on an odd numbered date. R does not start on even numbered date.

76. Which of the following combination is true?

A. March-T

B. August-W

C. April-U

D. November-Q

E. March-S

77. Four of the following five are alike in a certain way and form a group. Which of the following does not belong to the group?

A. Q

B. The one who starts immediately before V

C. The one who starts immediately after T

D. U

E. P

78. Who among the following person has started on November 17th?

A. The one who started immediately after U

B. Q

C. The one who started two persons after V

D. R

E. P

Top Expected Puzzle and Seating Questions for Upcoming Bank Prelims Exams 2021 (English Version)

79. On which of the following month and date R starts his business?

- A. March 06
- B. November 06
- C. August 17
- D. None of the above
- E. March 17

80. How many persons are starting the business between Q and T?

- A. Four
- B. One
- C. Three
- D. Two
- E. None

Explanation

March 06	Q
March 17	R
April 06	P
April 17	V
August 06	T
August 17	W
November 06	U
November 17	S

V has started on April 17.

T has started the business on even numbered date after V.

Only one person is starting the business between T and U.

From the above condition, there are three possibilities.

	Case1	Case2	Case3
March 06			
March 17			
April 06			U
April 17	V	V	V
August 06	U	T	T
August 17			
November 06	T	U	
November 17			

W has started two persons before S

S has started on an odd numbered date.

	Case1	Case2	Case3
March 06			
March 17			
April 06			U
April 17	V	V	V
August 06	U	T	T
August 17	W	W	W
November 06	T	U	
November 17	S	S	S

R does not start on an even numbered date.

P is starting the business on either November or April.

Top Expected Puzzle and Seating Questions for Upcoming Bank Prelims Exams 2021 (English Version)

	Case1	Case2	Case3
March 06	Q	Q	Q
March 17	R	R	R
April 06	P	P	U
April 17	V	V	V
August 06	U	T	T
August 17	W	W	W
November 06	T	U	P
November 17	S	S	S

The number of persons starting between Q and R is same as between U and S.

From the above condition, case1 and case3 get eliminated. case2 shows the final arrangement.

	Case1	Case2	Case3
March 06	Q	Q	Q
March 17	R	R	R
April 06	P	P	U
April 17	V	V	V
August 06	U	T	T
August 17	W	W	W
November 06	T	U	P
November 17	S	S	S

76) Answer: B

77) Answer: C

78) Answer: A

79) Answer: E

80) Answer: C

Direction (81-85): Answer the questions based on the information given below.

Ten persons viz. A, B, C, D, E, F, G, H, I and J are attending an interview on 5 different dates viz. 7th, 12th, 18th, 25th and 30th of March and

April of the same year, but not necessarily in the same order.

F attends the interview in a prime numbered date and three persons away from I. D attends the interview on an even date of March after I. Two persons attend the interview between D and J who attends six persons before E. B attends the interview immediately before E. The number of persons attending the interview before C is the same as after H. A attends the interview immediately before H.

81. Who among the following person attends the interview on 12th April?

- A.C
- B.H
- C.A
- D.B
- E.None of these

82. How many persons attend the interview between A and J?

- A.One
- B.None
- C.Three
- D.Two
- E.More than three

83. Four of the following five are alike in a certain way and hence form a group. Find the one that doesn't belong to that group.

- A.C
- B.G

Top Expected Puzzle and Seating Questions for Upcoming Bank Prelims Exams 2021 (English Version)

- C.H
D.A
E.D

84. If all the persons attend the interview in alphabetical order, then who among the following persons attends the interview on 18th April?

- A.G
B.H
C.F
D.E
E.None of these

85. In which of the following date does G attends the interview?

- A.7th April
B.18th April
C.25th March
D.18th March
E.None of these

Explanation

	7 th	12 th	18 th	25 th	30 th
March	C	J	I	G	D
April	F	B	E	A	H

1. F attends the interview in a prime numbered date and three persons away from I. D attends the interview on an even date of March after I.

		7 th	12 th	18 th	25 th	30 th
Case 1	March	F			I	D
	April					
Case 2	March			I		D
	April	F				

2. Two persons attend the interview between D and J who attends six persons before E. B attends the interview immediately before E.

		7 th	12 th	18 th	25 th	30 th
Case 1	March	F	J		I	D
	April		B	E		
Case 2	March		J	I		D
	April	F	B	E		

3. The number of persons attending the interview before C is the same as after H. A attends the interview immediately before H. Hence, case 1 gets eliminated.

		7 th	12 th	18 th	25 th	30 th
Case 1	March	F	J		I	D
	April		B	E		
Case 2	March	C	J	I	G	D
	April	F	B	E	A	H

81) Answer: D

82) Answer: E

83) Answer: A

84) Answer: B

85) Answer: C

Direction (86-90): Answer the questions based on the information given below.

In a jewellery shop, eight different jewels viz. Antique, Bridal, Fashion, Filigree, Handmade, Kundan, Minakari and Navratna were sold in September, October, November and December of 2018 and 2019, but not necessarily in the same order. Only one jewel was sold in the same month of the same year.

Minakari was sold in the month with 30 days but not in the year 2019. Bridal was sold two jewels after Minakari. No jewels were sold after

Top Expected Puzzle and Seating Questions for Upcoming Bank Prelims Exams 2021 (English Version)

Navratna. Handmade was sold in the month with 31 days after Bridal. Antique was sold two jewels before Handmade. Kundan was sold in the same month as Bridal. More than two jewels were sold between Filigree and Fashion which was sold after Filigree.

86. Which of the following jewel was sold in October 2018?

- A. Antique
- B. Filigree
- C. Fashion
- D. Kundan
- E. None of these

87. How many months are there between in which Minakari and Bridal were sold?

- A. Eight
- B. Two
- C. Seven
- D. Nine
- E. None of these

88. Four of the following five are alike in a certain way and hence form a group. Find the one that doesn't belong to that group.

- A. Handmade
- B. Filigree
- C. Minakari
- D. Antique
- E. Kundan

89. In which of the following month and year does Fashion was sold?

- A. October, 2018

- B. September, 2019
- C. November, 2019
- D. December, 2018
- E. None of these

90. The number of jewels sold before Antique is the same as the number of jewels sold after _____.

- A. Kundan
- B. Handmade
- C. Fashion
- D. Filigree
- E. Bridal

Explanation

	2018	2019
September	Kundan	Bridal
October	Filigree	Handmade
November	Minakari	Fashion
December	Antique	Navratna

1. Minakari was sold in the month with 30 days but not in the year 2019. Bridal was sold two jewels after Minakari. No jewels were sold after Navratna.

	Case 1		Case 2	
	2018	2019	2018	2019
September	Minakari			Bridal
October				
November	Bridal		Minakari	
December		Navratna		Navratna

2. Handmade was sold in the month with 31 days after Bridal. Antique was sold two jewels

Top Expected Puzzle and Seating Questions for Upcoming Bank Prelims Exams 2021 (English Version)

before Handmade. Kundan was sold in the same month as Bridal.

	Case 1		Case 1a		Case 2	
	2018	2019	2018	2019	2018	2019
September	Minakari		Minakari		Kundan	Bridal
October	Antique			Handmade		Handmade
November	Bridal	Kundan	Bridal	Kundan	Minakari	
December	Handmade	Navratna	Antique	Navratna	Antique	Navratna

3. More than two jewels were sold between Filigree and Fashion which was sold after Filigree. Hence, cases 1 and 1a get eliminated.

	Case 1		Case 1a		Case 2	
	2018	2019	2018	2019	2018	2019
September	Minakari		Minakari		Kundan	Bridal
October	Antique			Handmade	Filigree	Handmade
November	Bridal	Kundan	Bridal	Kundan	Minakari	Fashion
December	Handmade	Navratna	Antique	Navratna	Antique	Navratna

86) Answer: B

87) Answer: D

88) Answer: A

89) Answer: C

90) Answer: E

Direction (91-95): Study the following information carefully and answer the questions given below.

Six different appliances viz. Cookware, Fridge, Grinder, Mixer, Oven and TV are advertised on a telemarketing channel from 6pm to 12 mid night. Each appliance is advertised only for one hour. These appliances are of different brands viz. Hawkins, LG, Pigeon, Preeti, Prestige and Sony. All the information is not necessarily in the same order.

Oven was advertised fourth and either immediately before or immediately after the appliance in Preeti brand. Fridge was advertised two appliances before the appliance in Preeti brand. The appliance advertised three appliances after Fridge is Pigeon brand. Cookware in Hawkins was advertised at a prime numbered hour but not the last. Mixer was advertised immediately after the appliance in Prestige brand. More than three appliances were advertised between Grinder and TV, which is neither Pigeon nor LG brand.

91. Which of the following brand is TV?

- A. Hawkins
- B. Preeti
- C. Sony
- D. Prestige
- E. None of these

92. In which of the following time does the Grinder advertisement end?

- A. 10pm
- B. 9pm
- C. 11pm
- D. 8pm
- E. None of these

93. Which of the following appliance was advertised at 7.30pm?

- A. TV
- B. Cookware
- C. Oven

Top Expected Puzzle and Seating Questions for Upcoming Bank Prelims Exams 2021 (English Version)

- D.Mixer
E.None of these

94. The appliance in LG brand was advertised at which of the following time?

- A.8pm
B.9pm
C.7pm
D.6pm
E.None of these

95. If all the appliances are advertised in reverse alphabetical order, then which of the following appliance was advertised second last?

- A.The one in Preeti brand
B.The one in Prestige brand
C.The one in Pigeon brand
D.The one in LG brand
E.None of these

Explanation

Time	6pm	7pm	8pm	9pm	10pm	11pm
Appliance	TV	Cookware	Fridge	Oven	Mixer	Grinder
Brand	Sony	Hawkins	LG	Prestige	Preeti	Pigeon

1. Oven was advertised fourth and either immediately before or immediately after the appliance in Preeti brand. Fridge was advertised two appliances before the appliance in Preeti brand.

	Time	6pm	7pm	8pm	9pm	10pm	11pm
Case 1	Appliance	Fridge			Oven		
	Brand			Preeti			
Case 2	Appliance			Fridge	Oven		
	Brand					Preeti	

2. The appliance advertised three appliances after Fridge is Pigeon brand. Cookware in Hawkins was advertised at a prime numbered hour but not the last.

	Time	6pm	7pm	8pm	9pm	10pm	11pm
Case 1	Appliance	Fridge	Cookware		Oven		
	Brand		Hawkins	Preeti	Pigeon		
Case 2	Appliance		Cookware	Fridge	Oven		
	Brand		Hawkins			Preeti	Pigeon

3. Mixer was advertised immediately after the appliance in Prestige brand. More than three appliances advertised between Grinder and TV, which is neither Pigeon nor LG brand.

	Time	6pm	7pm	8pm	9pm	10pm	11pm
Case 1	Appliance	Fridge	Cookware		Oven		Mixer
	Brand		Hawkins	Preeti	Pigeon	Prestige	
Case 2	Appliance	TV	Cookware	Fridge	Oven	Mixer	Grinder
	Brand	Sony	Hawkins	LG	Prestige	Preeti	Pigeon

91) Answer: C

92) Answer: E

93) Answer: B

94) Answer: A

95) Answer: D

Direction (96-100): Study the following information carefully and answer the below questions

There are four floors in an apartment with two lifts Viz., Lift-1, and Lift-2. Eight persons-A, B, C, D, E, F, G, and H are using these two lifts to reach certain floors of the apartment. The lowermost floor is numbered as 1 and the floor above is numbered as 2 and so on, No two persons use the same lift on the same floor.

Top Expected Puzzle and Seating Questions for Upcoming Bank Prelims Exams 2021 (English Version)

Only one floor is between A and G, both are using the same lift. Neither B nor D using the lift on the same floor of C. D is getting into the lift immediately above H. Both C and E are using the same lift, E gets in above C. Either D or H is getting into the lift on the same floor of A. F does not get into the lift on an odd numbered floor. A is getting into the lift on an even numbered floor but not an even numbered lift.

96. Which of the following statement is true?

- A. G gets in at even numbered floor
- B. Only one floor is between E and D
- C. A gets in at floor number four
- D. D gets in immediately above B
- E. None is true.

97. On which of the following floor number does C get in?

- A. Third
- B. Fourth
- C. Second
- D. First
- E. None of these

98. Who among the following persons is getting into the lift-1 and lift-2 respectively on floor number three?

- A. A, F
- B. G, F
- C. C, H
- D. B, E
- E. E, B

99. Who among the following person gets into the lift on floor number two?

- A. The one who gets in with the same floor of D
- B. C
- C. H
- D. The one who gets in at immediately above E
- E. F

100. Which of the following floor and lift does G use?

- A. Floor-4, Lift-1
- B. Floor-3, Lift-2
- C. Floor-2, Lift-1
- D. Floor-1, Lift-2
- E. None of the above

Explanation

Floor	Lift-1	Lift-2
4	G	F
3	E	B
2	A	D
1	C	H

A is getting into the lift on an even numbered floor but not an even numbered lift.

Only one floor between A and G, both are using the same lift.

From the above condition, there are two possibilities.

Top Expected Puzzle and Seating Questions for Upcoming Bank Prelims Exams 2021 (English Version)

	Case-1		Case-2	
Floor	Lift-1	Lift-2	Lift-1	Lift-2
4	A		G	
3				
2	G		A	
1				

D is getting into the lift immediately above H.
 Either D or H is getting into the lift on the same floor of A.
 From the above condition, there are three possibilities.

	Case-1		Case-2		Case-2a	
Floor	Lift-1	Lift-2	Lift-1	Lift-2	Lift-1	Lift-2
4	A	D	G		G	
3		H				D
2	G		A	D	A	H
1				H		

F does not get into the lift on an odd numbered floor.
 Both C and E are using the same lift, E gets in above C.

	Case-1		Case-2		Case-2a	
Floor	Lift-1	Lift-2	Lift-1	Lift-2	Lift-1	Lift-2
4	A	D	G	F	G	F
3	E	H	E	B	E	D
2	G	F	A	D	A	H
1	C	B	C	H	C	B

Neither B nor D using the lift on same floor of C
 From the above condition, Case1 and case2a were dropped.
 Finally, case2 shows the final arrangement.

	Case1		Case2		Case2a	
Floor	Lift-1	Lift-2	Lift-1	Lift-2	Lift-1	Lift-2
4	A	D	G	F	G	F
3	E	H	E	B	E	D
2	G	F	A	D	A	H
1	C	B	C	H	C	B

- 96) Answer: A
 97) Answer: D
 98) Answer: E
 99) Answer: A
 100) Answer: A

Direction (101-105): Answer the questions based on the information given below.

Eight persons viz. A, B, C, D, E, F, G and H are going to parlour on different dates viz. 3rd, 8th, 12th, 15th, 23rd, 26th, 29th and 31st of the same month, but not necessarily in the same order.
 B goes to the parlour on a prime date and immediately before F. The number of persons goes to the parlour before B is the same as the number of persons goes to the parlour after D. E goes to the parlour on an even numbered date.
 More than two persons go to the parlour between D and E. G goes to the parlour immediately before D and three persons away from H. C goes to the parlour after A but not immediately after.

101. What is the position of C with respect to B?
 A. Two persons after
 B. Four persons after
 C. Five persons after
 D. Two persons before
 E. None of these

102. Who among the following person goes to the parlour on 12th?
 A. D

Top Expected Puzzle and Seating Questions for Upcoming Bank Prelims Exams 2021 (English Version)

- B.F
- C.A
- D.E
- E.None of these

103. In which of the following date F goes to the parlour?

- A.31st
- B.26th
- C.8th
- D.15th
- E.None of these

104. How many days are there between the dates on which D and E go to the parlour?

- A.18
- B.17
- C.19
- D.16
- E.None of these

105. If 1st of that month is Thursday, then on which of the following day does A go to the parlour?

- A.Sunday
- B.Wednesday
- C.Friday
- D.Saturday
- E.Monday

Explanation

Date	3 rd	8 th	12 th	15 th	23 rd	26 th	29 th	31 st
Person	G	D	A	H	C	E	B	F

1. B goes to the parlour on a prime date and immediately before F. The number of persons goes to the parlour before B is the same as the number of persons goes to the parlour after D.

	Date	3 rd	8 th	12 th	15 th	23 rd	26 th	29 th	31 st
Case 1	Person	B	F						D
Case 2	Person				D	B	F		
Case 3	Person		D					B	F

2. E goes to the parlour on an even numbered date. More than two persons go to the parlour between D and E. Hence, case 2 gets eliminated.

	Date	3 rd	8 th	12 th	15 th	23 rd	26 th	29 th	31 st
Case 1	Person	B	F	E					D
Case 2	Person				D	B	F		
Case 3	Person		D				E	B	F

3. G goes to the parlour immediately before D and three persons away from H. C goes to the parlour after A but not immediately after. Hence, case 1 gets eliminated.

	Date	3 rd	8 th	12 th	15 th	23 rd	26 th	29 th	31 st
Case 1	Person	B	F	E	H			G	D
Case 3	Person	G	D	A	H	C	E	B	F

101) Answer: D

102) Answer: C

103) Answer: A

104) Answer: B

105) Answer: E

Direction (106-110): Study the following information carefully and answer the below questions.

Eight banking aspirants-P, Q, R, S, T, U, V, and W are applying for the exam one after another but not necessarily in the same order.

Top Expected Puzzle and Seating Questions for Upcoming Bank Prelims Exams 2021 (English Version)

T is applied as the third person either from the first or the last. The number of persons applying before T is the same as the number of persons applying after W. Only three persons are applying between T and R. P is the last person to apply for the exam. U is applying immediately before S. The number of persons applying between V and W is the same as the number of persons applying between W and P.

106. Who among the following person applied fourth from the last?

- A.The one who was applied immediately before W
- B.R
- C.S
- D.The one who was applied immediately after W
- E.None of these

107. How many persons are applied between U and V?

- A.One
- B.Two
- C.Three
- D.Four
- E.More than four

108. Which of the following statement is/are true?

- I. U is the first person to apply for the exam
- II. Only two persons are applied between Q and P
- III. T applies immediately after V

- A.Both I and II
- B.Only III
- C.Both I and III
- D.Only I
- E.All I, II, and III

109. What is the position of S from the first?

- A.Fifth
- B.Sixth
- C.Second
- D.Third
- E.Fourth

110. As many persons are applied before V is the same as after ____?

- A.Q
- B.W
- C.P
- D.U
- E.R

Explanation

1	U
2	S
3	T
4	V
5	Q
6	W
7	R
8	P

T is applied as the third person either from the first or the last.

Top Expected Puzzle and Seating Questions for Upcoming Bank Prelims Exams 2021 (English Version)

The number of persons applying before T is the same as the number of persons applying after W.

From the above condition, there are two possibilities.

	Case1	Case2
1		
2		
3	T	W
4		
5		
6	W	T
7		
8		

Only three persons are applying between T and R.

P is the last person to apply for the exam

U is applying immediately before S.

From the above condition, there are three possibilities.

	Case1	Case2	Case1a
1	U		
2	S	R	
3	T	W	T
4		U	U
5		S	S
6	W	T	W
7	R		R
8	P	P	P

The number of persons applying between V and W is the same as the number of persons applying between W and P.

From the above condition, case2 and case1a get eliminated. Case1 shows the final arrangement.

	Case1	Case2	Case1a
1	U		
2	S	R	
3	T	W	T
4	V	U	U
5	Q	S	S
6	W	T	W
7	R		R
8	P	P	P

106) Answer: A

107) Answer: B

108) Answer: A

109) Answer: C

110) Answer: A

Direction (111-115): Study the following information carefully and answer the below questions.

Nine persons- E, F, G, H, I, J, K, L, and M are getting the appointment in the hospital one after another but not necessarily in the same order. K gets three persons before H. At least two persons get an appointment between K and E who gets before K. E does not get either first or last. The number of persons get between K and E is the same as the number of persons get

Top Expected Puzzle and Seating Questions for Upcoming Bank Prelims Exams 2021 (English Version)

between I and F. F gets immediately before K. H and I are not getting adjacent to each other. J gets two persons after I. G gets immediately before M. J and L get on adjacent to each other.

111. How many persons get the appointment before F?

- A.As many persons get the appointment after G
- B.Five
- C.Three
- D.As many persons get the appointment after F
- E.None

112. Who among the following persons gets an appointment before K?

- I. E
- II. G
- III. I
- IV. M
- A.Only II and III
- B.Only III and IV
- C.Only I and III
- D.Only II and IV
- E.Only I and II

113. J gets the appointment as the ___ person.

- A.Third
- B.Fourth
- C.Fifth
- D.Sixth
- E.Second

114. If all the persons are arranged in alphabetical order from last, then how many persons are unchanged in their positions?

- A.Four
- B.Three
- C.Two
- D.One
- E.Five

115. If L and K are interchanged their positions then G and F did the same then who among the following person gets the appointment immediately before K?

- A.J
- B.E
- C.I
- D.F
- E.M

Explanation

	Person
1	I
2	E
3	J
4	L
5	F
6	K
7	G
8	M
9	H

We have,

- K gets three persons before H.

Top Expected Puzzle and Seating Questions for Upcoming Bank Prelims Exams 2021 (English Version)

- At least two persons get appointment between K and E who gets before K.
- E does not get either first or last.

From the above condition, there are three possibilities.

	Case1	Case2	Case2a
1			
2	E		E
3		E	
4			
5	K		
6		K	K
7			
8	H		
9		H	H

Again we have,

- The number of persons who get between K and E is the same as the number of persons who get between I and F.
- F gets immediately before K.
- H and I are not getting adjacent to each other.

	Case1	Case2	Case2a
1	I		I
2	E	I	E
3		E	
4	F		
5	K	F	F
6		K	K
7			
8	H		
9		H	H

Again we have,

- J gets two persons after I.
- G gets immediately before M.
- J and L get adjacent to each other.

From the above condition, case1 and case2 get eliminated. Case2a shows the final arrangement.

	Case1	Case2	Case2a
1	I		I
2	E	I	E
3	J	E	J
4	F	J	L
5	K	F	F
6	G	K	K
7	M	G	G
8	H	M	M
9		H	H

111) Answer: D

112) Answer: C

113) Answer: A

114) Answer: D

Top Expected Puzzle and Seating Questions for Upcoming Bank Prelims Exams 2021 (English Version)

115) Answer: A

Direction (116-120): Study the following information carefully and answer the questions given below:

Eleven persons A, B, C, D, E, F, G, H, I, J and K are buying some products one after another but not necessarily in the same order.

The number of persons buying products after H is same as the number of persons buying product before I. At most two persons are buying products before F. Only one person is buying between D and F. C is buying just before H. One person is buying between C and D. K is buying just before B and just after J. Two persons are buying product between G and J. A is buying the product just before E.

116. How many persons are buying their products after the one who buys just after H?

- A.Three
- B.Two
- C.More than three
- D.One
- E.None of these

117. Who among the following is buying just before G?

- A.E
- B.F
- C.B
- D.D
- E.None of these

118. If all the persons are arranged in alphabetical order from left to right starting from A, then find how many persons remain at the same position (excluding A) ?

- A.One
- B.None
- C.Two
- D.Four
- E.More than Four

119. Who among the following is buying exactly between D and B?

- A.E
- B.B
- C.A
- D.H
- E.None of these

120. How many persons are buying between E and K?

- A.Five
- B.Seven
- C.Three
- D.None
- E.Two

Explanation

At most two persons are buying products before F. Here we get 3 possible cases i.e. Case 1, Case 2 and Case 3. Only one person is buying between D and F.

Top Expected Puzzle and Seating Questions for Upcoming Bank Prelims Exams 2021 (English Version)

Serial number	Case 1	Case 2	Case 3
	Persons	Persons	Persons
11	F		D/
10		F	
9	D		F
8		D	
7			D/
6			
5			
4			
3			
2			
1			

One person is buying between C and D. C is buying just before H.

Serial number	Case 1	Case 2	Case 3
	Persons	Persons	Persons
11	F		
10		F	
9	D		F
8		D	
7	C		D
6	H	C	
5		H	C
4			H
3			
2			
1			

The number of persons buying products after H is same as the number of persons buying product before I. Case 1 is ruled out now. K is buying just before B and just after J.

Top Expected Puzzle and Seating Questions for Upcoming Bank Prelims Exams 2021 (English Version)

Serial number	Case 1	Case 2	Case 3
	Persons	Persons	Persons
11	F		
10		F	
9	D		F
8		D	I
7	C	I	D
6	H	C	
5		H	C
4		J/	H
3		J/K	J
2		K/B	K
1		B/	B

Two persons are buying product between G and J. Here Case 2 is eliminated.

Serial number	Case 2	Case 3
	Persons	Persons
11		
10	F	
9		F
8	D	I
7	I	D
6	C	G
5	H	C
4	J/	H
3	J/K	J
2	K/B	K
1	B/	B

A is buying the product just before E. So, the final arrangement is-

Top Expected Puzzle and Seating Questions for Upcoming Bank Prelims Exams 2021 (English Version)

Case 3
Persons
A
E
F
I
D
G
C
H
J
K
B

116) Answer: B

117) Answer: D

118) Answer: A

119) Answer: D

120) Answer: B

Direction (121-125): Answer the questions based on the information given below.

Nine persons viz. Adhi, Akila, Giri, Hira, Jai, Maya, Nitin, Riya and Sara were working in a hospital with different designations viz. Dean, Administrator, Surgeon, Specialist Doctor (SD), General Doctor (GD), Chief Nurse (CN), Nurse, Physician Assistant (PA) and Medical Intern (MI), but not necessarily in the same order. Dean is the highest designated post while Medical Intern is the lowest designated post. Riya was designated five persons after Maya who was not designated the highest. Jai was

two persons junior to Maya. Only four persons designated between Jai and Hira who was the immediate junior to Nitin. Adhi was senior to Maya. The number of persons senior to Sara is one less than the number of persons junior to Akila who is junior to Giri.

121. Who among the following persons is the General Doctor?

- A.Sara
- B.Akila
- C.Giri
- D.Jai
- E.None of these

122. As many persons were junior to Maya as senior to _____.

- A.Riya
- B.Hira
- C.Sara
- D.Nitin
- E.None of these

123. What is the designation of Akila?

- A.Specialist Doctor
- B.Chief Nurse
- C.Physician Assistant
- D.Nurse
- E.None of these

124. How many persons are designated between Adhi and Hira?

- A.One

Top Expected Puzzle and Seating Questions for Upcoming Bank Prelims Exams 2021 (English Version)

- B. Two
- C. Three
- D. More than three
- E. None

125. Who among the following persons is fourth senior to Riya?

- A. Sara
- B. Maya
- C. Adhi
- D. No such person
- E. None of these

Explanation

Designation	Person
Dean	Adhi
Administrator	Maya
Surgeon	Sara
Specialist Doctor (SD)	Jai
General Doctor (GD)	Giri
Chief Nurse (CN)	Akila
Nurse	Riya
Physician Assistant (PA)	Nitin
Medical Intern (MI)	Hira

1. Riya was designated five persons after Maya who was not designated the highest. Jai was two persons junior to Maya.

	Case 1	Case 2	Case 3
Designation	Person	Person	Person
Dean			
Administrator	Maya		
Surgeon		Maya	
Specialist Doctor (SD)	Jai		Maya
General Doctor (GD)		Jai	
Chief Nurse (CN)			Jai
Nurse	Riya		
Physician Assistant (PA)		Riya	
Medical Intern (MI)			Riya

2. Only four persons designated between Jai and Hira who was the immediate junior to Nitin. Hence, case 2 and case 3 are get eliminated. Adhi was senior to Maya.

	Case 1	Case 2	Case 3
Designation	Person	Person	Person
Dean	Adhi		Hira
Administrator	Maya		
Surgeon		Maya	
Specialist Doctor (SD)	Jai		Maya
General Doctor (GD)		Jai	
Chief Nurse (CN)			Jai
Nurse	Riya		
Physician Assistant (PA)	Nitin	Riya	
Medical Intern (MI)	Hira		Riya

3. The number of persons senior to Sara is one less than the number of persons junior to Akila who is junior to Giri.

Top Expected Puzzle and Seating Questions for Upcoming Bank Prelims Exams 2021 (English Version)

Designation	Person
Dean	Adhi
Administrator	Maya
Surgeon	Sara
Specialist Doctor (SD)	Jai
General Doctor (GD)	Giri
Chief Nurse (CN)	Akila
Nurse	Riya
Physician Assistant (PA)	Nitin
Medical Intern (MI)	Hira

121) Answer: C

122) Answer: D

123) Answer: B

124) Answer: D

125) Answer: A

Direction (126-130): Study the following information carefully and answer the below questions.

Seven persons L, M, N, O, P, Q, and R are working in a restaurant with different grade position such as General Manager(GM), Assistant Manager(AM), Deputy Assistant Manager(DAM), Food Director, Restaurant Manager, Food Runner, and Cashier. Their positions are given in descending order such as General Manager is the highest position & Cashier is the lowest position.

R is a food director. The number of positions between L and P is the same as between R and Q. Two persons are holding the position between N and M. P holds three positions senior

to Q. Only one person holds the position between R and N. O neither holds the adjacent position of M nor N.

126. Who among the following person is the Food Runner?

A. the one who holds the immediate junior position of P

B. R

C. O

D. the one who holds the immediate senior position of O

E. L

127. Four of the following are alike in a certain way. Which among the following one does not belong to the group?

A. General Manager-L

B. Assistant Manager-N

C. Food director-M

D. Cashier-O

E. Deputy Assistant Manager-P

128. Which of the following statement is/are true?

I). N holds a higher position than L

II). Two persons are holding the position between P and Q

III). O is holding a lower position than Q.

A. Both I and II

B. Only I

C. Both II and III

D. Only II

Top Expected Puzzle and Seating Questions for Upcoming Bank Prelims Exams 2021 (English Version)

E. None of these

129. How many persons are holding a higher position than M?

- A. Three
- B. Two
- C. One
- D. Five
- E. Four

130. If L is related to Assistant Manager and P is related to the Food director in a certain way.

Then, in the same way, who among the following is related to Cashier?

- A. O
- B. Q
- C. M
- D. N
- E. None of the above

Explanation

General Manager	L
Assistant Manager	N
Deputy Assistant Manager	P
Food Director	R
Restaurant Manager	M
Food Runner	Q
Cashier	O

R is a food director.

Only one person holds the position between R and N.

From the above condition, there are two possibilities.

	Case1	Case2
General Manager		
Assistant Manager	N	
Deputy Assistant Manager		
Food Director	R	R
Restaurant Manager		
Food Runner		N
Cashier		

Two persons are holding the position between N and M.

O neither holds the adjacent position of M nor N.

	Case1	Case2
General Manager		O
Assistant Manager	N	
Deputy Assistant Manager		M
Food Director	R	R
Restaurant Manager	M	
Food Runner		N
Cashier	O	

P holds three positions senior to Q.

The number of positions between L and P is the same as between R and Q.

From the above condition, case2 gets

eliminated. Case1 shows the final arrangement.

	Case1	Case2
General Manager	L	O
Assistant Manager	N	P
Deputy Assistant Manager	P	M
Food Director	R	R
Restaurant Manager	M	Q
Food Runner	Q	N
Cashier	O	L

126) Answer: D

127) Answer: C

Top Expected Puzzle and Seating Questions for Upcoming Bank Prelims Exams 2021
(English Version)

128) Answer: C

129) Answer: E

130) Answer: B

Direction (131-135): Study the following information carefully and answer the questions given below.

Eight persons viz. P, Q, R, S, T, U, V and W holding different roles viz. Managing Director (MD), Chief Executive Officer (CEO), Chief Operations Officer (COO), Chief Finance Officer (CFO), Chief Technology Officer (CTO), Chief Marketing Officer (CMO), Chief Legal Officer (CLO) and Manager are gathered for a board meeting, but not necessarily in the same order.

Note: The Managing Director is the senior most persons followed by the CEO and so on where the Manager is the junior most.

Not more than two persons are junior to T. S is three persons senior to T. Only one person is designated between S and U who is not junior to S. Q is the immediate junior of W who is neither CMO nor CLO. The number of persons designated between W and T is the same as the number of persons designated between Q and V. P is senior to R but is not the senior most.

131. Who among the following person is the Managing Director?

A.R

B.U

C.W

D.S

E.None of these

132. Which of the following is the role of Q?

A.CFO

B.CMO

C.CTO

D.CEO

E.None of these

133. How many persons were designated between P and W?

A.One

B.Two

C.Three

D.More than three

E.None of these

134. If S is related to CTO and R is related to CMO in a certain way, then which of the following role is related to Q?

I. CLO

II.COO

III. CFO

A.Only I

B.Only II

C.Only III

D.Either I or II

E.None of these

135. Which of the following statement is true with respect to the final arrangement?

A.Three persons are senior to S

B.The number of persons senior to W as junior to T

Top Expected Puzzle and Seating Questions for Upcoming Bank Prelims Exams 2021 (English Version)

C.V is the junior most persons

D.R is senior to T

E.None is true

Explanation

Role	MD	CEO	COO	CFO	CTO	CMO	CLO	Manager
Person	U	P	S	W	Q	T	V	R

1. Not more than two persons are junior to T. S is three persons senior to T. Only one person is designated between S and U who is not junior to S.

	Role	MD	CEO	COO	CFO	CTO	CMO	CLO	Manager
Case 1	Person	U		S			T		
Case 2	Person		U		S			T	
Case 3	Person			U		S			T

2. Q is the immediate junior of W who is neither CMO nor CLO. The number of persons designated between W and T is the same as the number of persons designated between Q and V. Hence, case 3 gets eliminated.

	Role	MD	CEO	COO	CFO	CTO	CMO	CLO	Manager
Case 1	Person	U		S	W	Q	T	V	
Case 2	Person		U		S	W	Q	T	V
Case 3	Person	W	Q	U		S			T

3. P is senior to R but is not the senior most.

Hence, case 2 gets eliminated.

	Role	MD	CEO	COO	CFO	CTO	CMO	CLO	Manager
Case 1	Person	U	P	S	W	Q	T	V	R
Case 2	Person		U		S	W	Q	T	V

131) Answer: B

132) Answer: C

133) Answer: A

134) Answer: D

135) Answer: E

Direction (136-140): Study the following information carefully and answer the questions given below.

Seven persons viz. G, H, I, J, K, L and M are wearing different brand shirts viz. Ajio, Arrow, Lifestyle, Parx, Raymond, Roadster and Zodiac. Each shirt is of different colour viz. Black, Blue, Brown, Green, Pink, Red and Yellow. All the information is not necessarily in the same order. K wore Blue colour Roadster shirt. If M wore Raymond shirt, then I wore Pink shirt else I wore Red shirt. The person alphabetically preceding three persons before the one who wore Blue shirt wore Zodiac shirt and is immediately succeeding the one who wore Black shirt. L wore Ajio shirt. Neither G nor I wore Lifestyle shirt. M wore a Yellow shirt. Neither J nor L wore Brown colour shirt. J wore a Green shirt. The person who wore Arrow shirt is alphabetically two persons preceding the one who wore Parx, which is not Red colour.

136. Which of the following shirt was worn by I?

A.Arrow

B.Raymond

C.Parx

D.Zodiac

E.None of these

137. What is the colour of the Raymond shirt?

A.Green

B.Brown

C.Black

D.Yellow

E.None of these

Top Expected Puzzle and Seating Questions for Upcoming Bank Prelims Exams 2021 (English Version)

138. Which of the following shirt was worn by the one who is alphabetically preceding the one who wore Blue shirt?

- A.Parx
- B.Lifestyle
- C.Arrow
- D.Ajio
- E.None of these

139. Who among the following person is two persons succeeding the one who wore Pink shirt?

- A.K
- B.L
- C.M
- D.No such person
- E.None of these

140. Four of the following five are alike in a certain way and hence form a group. Find the one that doesn't belong to that group.

- A.G – Brown
- B.I – Green
- C.K – Red
- D.L – Yellow
- E.H – Red

Explanation

Person	G	H	I	J	K	L	M
Shirt	Arrow	Zodiac	Parx	Lifestyle	Roadster	Ajio	Raymond
Colour	Black	Brown	Pink	Green	Blue	Red	Yellow

1. K wore Blue colour Roadster shirt. If M wore Raymond shirt, then I wore Pink shirt else I wore Red shirt.

	Person	G	H	I	J	K	L	M
Case 1	Shirt					Roadster		Raymond
	Colour			Pink		Blue		
Case 2	Shirt					Roadster		
	Colour			Red		Blue		

2. The person alphabetically preceding three persons before the one who wore Blue shirt wore Zodiac shirt and is immediately succeeding the one who wore Black shirt. L wore Ajio shirt.

	Person	G	H	I	J	K	L	M
Case 1	Shirt		Zodiac			Roadster	Ajio	Raymond
	Colour	Black		Pink		Blue		
Case 2	Shirt		Zodiac			Roadster	Ajio	
	Colour	Black		Red		Blue		

3. Neither G nor I wore Lifestyle shirt. M wore a Yellow shirt. Neither J nor L wore Brown colour shirt. J wore a Green shirt.

	Person	G	H	I	J	K	L	M
Case 1	Shirt		Zodiac		Lifestyle	Roadster	Ajio	Raymond
	Colour	Black	Brown	Pink	Green	Blue		Yellow
Case 2	Shirt		Zodiac		Lifestyle	Roadster	Ajio	
	Colour	Black	Brown	Red	Green	Blue		Yellow
Case 2a	Shirt		Zodiac			Roadster	Ajio	Lifestyle
	Colour	Black	Brown	Red	Green	Blue		Yellow

4. The person who wore Arrow shirt is alphabetically two persons preceding the one who wore Parx, which is not Red colour.

	Person	G	H	I	J	K	L	M
Case 1	Shirt	Arrow	Zodiac	Parx	Lifestyle	Roadster	Ajio	Raymond
	Colour	Black	Brown	Pink	Green	Blue	Red	Yellow
Case 2	Shirt	Arrow	Zodiac	Parx	Lifestyle	Roadster	Ajio	
	Colour	Black	Brown	Red	Green	Blue	Pink	Yellow
Case 2a	Shirt	Arrow	Zodiac	Parx		Roadster	Ajio	Lifestyle
	Colour	Black	Brown	Red	Green	Blue	Pink	Yellow

136) Answer: C

137) Answer: D

Top Expected Puzzle and Seating Questions for Upcoming Bank Prelims Exams 2021 (English Version)

138) Answer: B

139) Answer: A

140) Answer: E

Direction (141-145): Study the following information carefully and answer the below questions

Nine persons - A, B, C, D, E, F, G, H and I are working in three different departments - Accounts, Finance, and IT, but not necessarily in the same order. Minimum two persons and maximum four persons are working in each department.

A works with E but does not work in the IT department. F does not work with E. Both F and I are working in the same department. I does not work in the Finance department. B neither work with C nor A. C works only with D. The number of persons working in the Accounts department is one more than the number of persons working in the IT department. H does not work in the Finance department.

141. Who among the following person works in the IT department?

- A.F
- B.A
- C.H
- D.C
- E.D

142. If A is related to H and C is related to D in a certain way. Then, who among the following person is related to I?

A.C

B.A

C.G

D.F

E.Either b or c

143. Which of the following statement is true with respect to the final arrangement?

A.F works in the Finance department

B.C works in the IT department

C.A works with H

D.Both D and I work in the same department

E.Both H and G work in a different department

144. Who among the following pair of persons working in the same department?

I. BI

II. GH

III. DG

IV. FH

A.Only I and II

B.Only III and IV

C.Only I and III

D.Only II and IV

E.Only I and IV

145. Four of the following are alike in a certain way and hence form a group. Which of the following one does not belong to that group?

A.FA

B.CE

C.HB

D.IC

Top Expected Puzzle and Seating Questions for Upcoming Bank Prelims Exams 2021 (English Version)

E.GH

Explanation

IT	Accounts	Finance
F, I, B	A, E, G, H	C, D

We have,

- A works with E but does not work in the IT department.
- F does not work with E.
- Both F and I are working in the same department.
- I does not work in the Finance department.

From the above condition, there are three possibilities.

	IT	Accounts	Finance
Case1	F, I	A, E	
Case2	F, I		A, E
Case2a		F, I	A, E

Again we have,

- B neither work with C nor A.
- C works only with D.
- The number of persons working in the Accounts department is one more than the number of persons working in the IT department.

From the above condition, case2 gets eliminated.

	IT	Accounts	Finance
Case1	F, I, B	A, E, G, H	C, D
Case2	F, I, B	C, D	A, E
Case2a	C, D	F, I, B	A, E, G, H

Again we have,

- H does not work in the Finance department.

From the above condition, Case2a get eliminated. Case1 shows the final arrangement.

	IT	Accounts	Finance
Case1	F, I, B	A, E, G, H	C, D
Case2a	C, D	F, I, B	A, E, G, H

141) Answer: A

142) Answer: D

143) Answer: C

144) Answer: A

145) Answer: E

Direction (146-150): Study the following information carefully and answer the questions given below:

There are eight persons P, Q, R, S, T, U, V, and W like 4 different animals- Cow, dog, Rabbit and Cat. Not more than two persons like same animal.

P and T like same animal but not Rabbit. W likes Cow. Either rabbit is liked by U or S, but not both. R and S like same animal. Q does not like cat. Cow is liked either by Q or V, but not both. If rabbit is liked by U, then V also liked rabbit, otherwise not. P, Q and R likes different animal. Q and R does not like dog. If Q likes cow, then U and V likes same animal but not dog. If P likes dog then R does not like rabbit.

146. Who among the following likes Dog?

I. P

Top Expected Puzzle and Seating Questions for Upcoming Bank Prelims Exams 2021 (English Version)

- II. U
 III. V
 A. Only I
 B. Only II
 C. Only III
 D. Both I and II
 E. Both II and III

147. Rabbit is liked by which pair?

- A. VW
 B. UV
 C. TS
 D. RT
 E. None of the above

148. Which of the following is correct?

- A. P likes cat
 B. U likes Cow
 C. S like cat
 D. P and U like same animal
 E. All are incorrect

149. Which is odd one out?

- A. QV
 B. UR
 C. TU
 D. WQ
 E. PU

150. U likes which animal?

- A. Cat
 B. Dog
 C. Cow

- D. Rabbit
 E. Cannot determine

Explanation

Final Arrangement:

Case-I(a)	
Person	Animals
P	Dog
Q	Cow
R	Cat
S	Cat
T	Dog
U	Rabbit
V	Rabbit
W	Cow

We have,

- P and T like same animal but not Rabbit.
- W likes Cow.
- Either rabbit is liked by U or S, but not both.
- R and S like same animal.

	Case-I	Case-II
Person	Animals	Animals
P		
Q		
R		Rabbit
S		Rabbit
T		
U	Rabbit	
V		
W	Cow	Cow

Top Expected Puzzle and Seating Questions for Upcoming Bank Prelims Exams 2021 (English Version)

Again we have,

- Q does not like cat.
- Cow liked either by Q or V, but not both.
- If rabbit is liked by U, then V also liked rabbit, otherwise not.
- P, Q and R likes different animal.
- Q and R does not like dog.

	Case-I(a)	Case-II(a)	Case-II(b)
Person	Animals	Animals	Animals
P	Dog	Dog/Cat	Dog/Cat
Q	Cow	Cow	Cow
R	Cat	Rabbit	Rabbit
S	Cat	Rabbit	Rabbit
T	Dog	Dog/Cat	Dog/Cat
U	Rabbit		
V	Rabbit		Cow
W	Cow	Cow	Cow

Case-II (b) gets eliminated because either Q or V likes cow but not both.

Again we have,

- If Q likes cow, then U and V likes same animal but not dog.
- If P likes dog then R does not like rabbit.

	Case-I(a)	Case-II(a)
Person	Animals	Animals
P	Dog	Dog
Q	Cow	Cow
R	Cat	Rabbit
S	Cat	Rabbit
T	Dog	Dog
U	Rabbit	Cat
V	Rabbit	Cat
W	Cow	Cow

So, case-II (a) gets eliminated because above condition is violating.

146) Answer: A

147) Answer: B

148) Answer: C

149) Answer: D

150) Answer: D

Direction (151-155): Answer the questions based on the information given below.

Nine persons P, Q, R, S, T, U, V, W, and X are sitting around a circular table facing the center but not necessarily in the same order. All the persons are sitting at an equal distance between them.

The one who sits second to the left of the one who sits adjacent to T sits third to the right of X. Two persons sit between S and W, none of them sits adjacent to T. U sits immediate right of S, but not adjacent to either T or X. V sits immediate left of Q, none of them sits adjacent to W. P sits adjacent to W, but not adjacent to T.

Top Expected Puzzle and Seating Questions for Upcoming Bank Prelims Exams 2021
(English Version)

Not more than one person sits between P and R when counted from the right of P.

151. How many persons are sitting between X and P when counted from the left of P?

- A.Three
- B.None
- C.Two
- D.More than three
- E.One

152. Who among the following sits third to the right of V?

- A.U
- B.W
- C.P
- D.S
- E.None of these

153. Who is sitting adjacent to R?

- A.W
- B.P
- C.T
- D.Both (a) and (b)
- E.Both (a) and (c)

154. Four of the following five pairs are alike in a certain way based on the given arrangement and so form a group. Which one of the following does not belong to that group?

- A.QU
- B.PT
- C.SQ

- D.WV
- E.XP

155. What is the position of Q with respect to P?

- A.3rd to the left
- B.4th to the left
- C.5th to the left
- D.2nd to the right
- E.None of these

Explanation

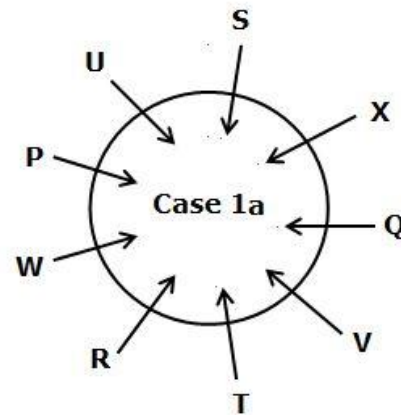

- The one who sits second to the left of the one who sits adjacent to T sits third to the right of X.

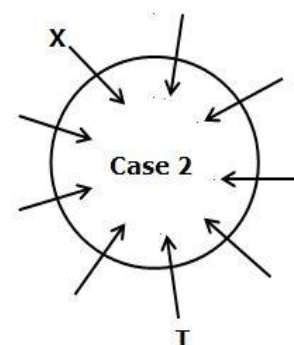
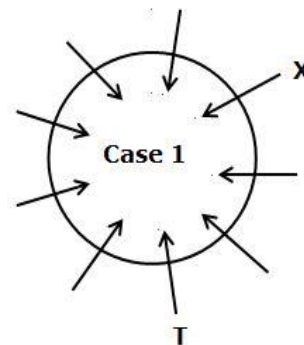

- Two persons sit between S and W, none of them sits adjacent to T.

Top Expected Puzzle and Seating Questions for Upcoming Bank Prelims Exams 2021
(English Version)

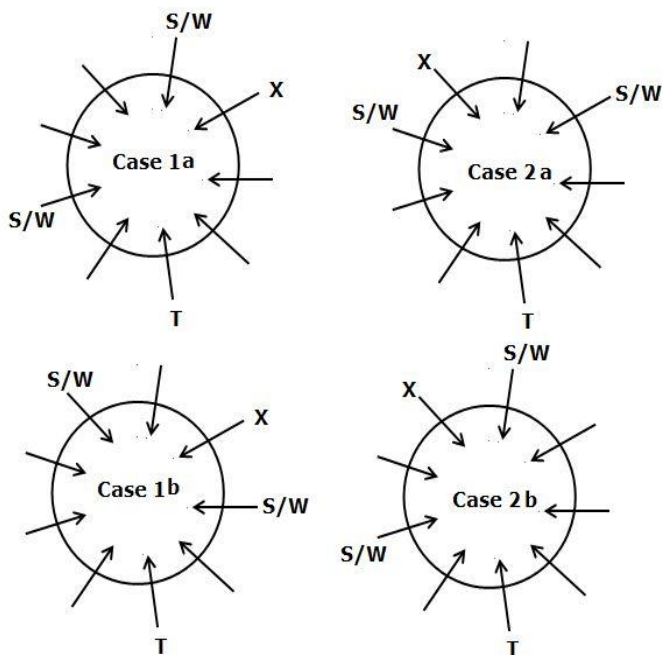

- U sits immediate right of S, but not adjacent to either T or X.
- V sits immediate left of Q, none of them sits adjacent to W.
- P sits adjacent to W, but not adjacent to T.
- Not more than one person sits between P and R when counted from the right of P.
- **So the final arrangement becomes:**

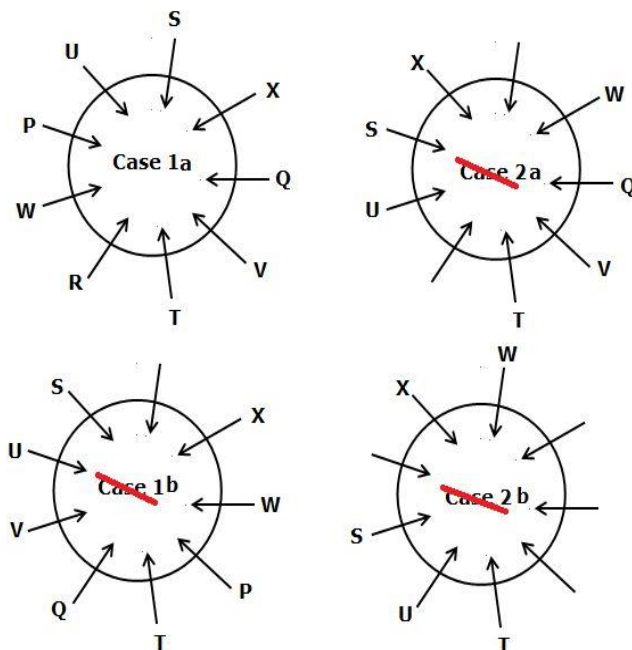

- 151) Answer: C
- 152) Answer: D
- 153) Answer: E
- 154) Answer: C
- 155) Answer: B

Direction (156-160): Study the following information carefully and answer the question below.

Eight persons P, Q, R, S, T, U, V and W are sitting around a circular table equidistant from each other. Each of them likes different soft drinks among Pepsi, Coca-Cola, Fanta, Sprite, Limca, Mirinda, Dew and Fruity but not in the same order. All of them facing towards the center of the table.

W and the one who likes dew sit adjacent to each other. More than three persons sit between V and Q when counted from the left of V. The one who likes Mirinda sits immediate left of Q. U likes limca but is not an immediate neighbour of both P or T. S sits 2nd to the right of P. The one

Top Expected Puzzle and Seating Questions for Upcoming Bank Prelims Exams 2021
(English Version)

who likes Fanta sits opposite to U. V doesn't like Mirinda. Neither R nor Q likes Fanta. Only two persons sit between P and T when counted in anticlockwise direction from T. Either T or P likes Mirinda. The person who likes Pepsi sits adjacent to both the one who likes Coca-Cola and the one who likes fruity.

156. If W sits immediate left of the one who likes Coca-Cola then who sits immediate right of R.

- A.V
- B.The one who likes Dew
- C.P
- D.The one who likes fruity
- E.Q

157. How many persons sit between U and the one who likes Mirinda when counted from the left of U.

- A.Three
- B.Five
- C.Six
- D.Four
- E.One

158. Who among the following person sits opposite to S.

- A.Q
- B.T
- C.The one who like pepsi
- D.The one who likes Fanta
- E.V

159. Four from the following five are related in a certain way and hence form a group. Find the one who doesn't belong to that group.

- A.W-limca
- B.T-pepsi
- C.P-Sprite
- D.S-Dew
- E.R-Fruity

160. Who among the following sits 2nd left of the one who sits immediate right of Q.

- A.V
- B.U
- C.T
- D.S
- E.R

Explanation

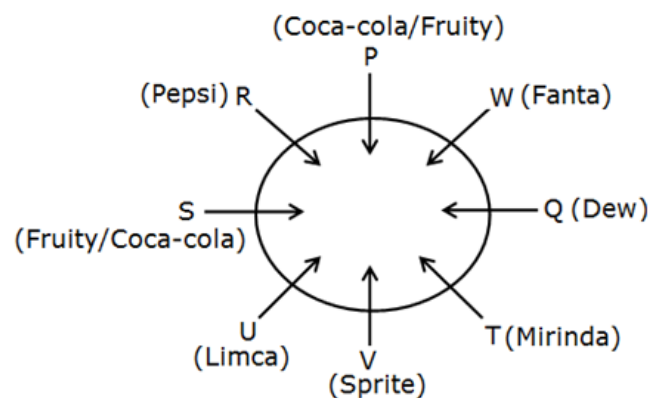

More than three persons sit between V and Q when counted from the left of V.

The one who likes Mirinda sits immediate left of Q.

V doesn't like Mirinda.

Here we get two possibilities.

Top Expected Puzzle and Seating Questions for Upcoming Bank Prelims Exams 2021
(English Version)

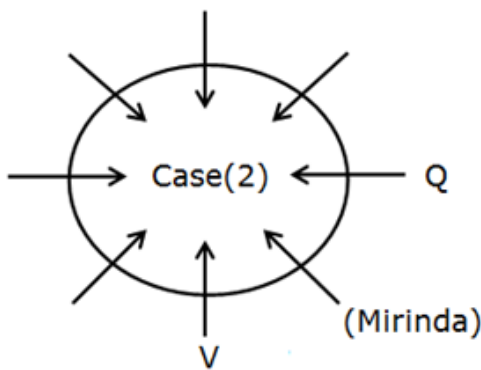
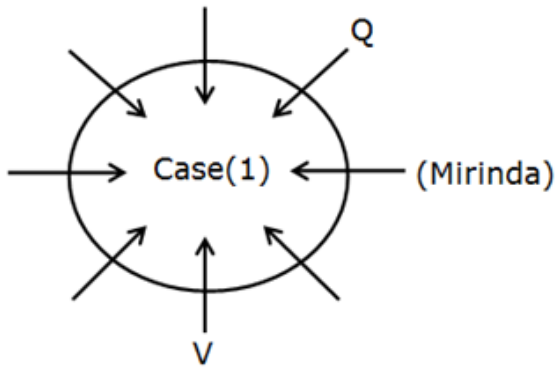

S sits 2nd to the right of P.

Only two persons sit between P and T when counted in anticlockwise direction from T. Either T or P likes Mirinda.

Here we get two more possibilities i.e. case (1a) and case (2a).

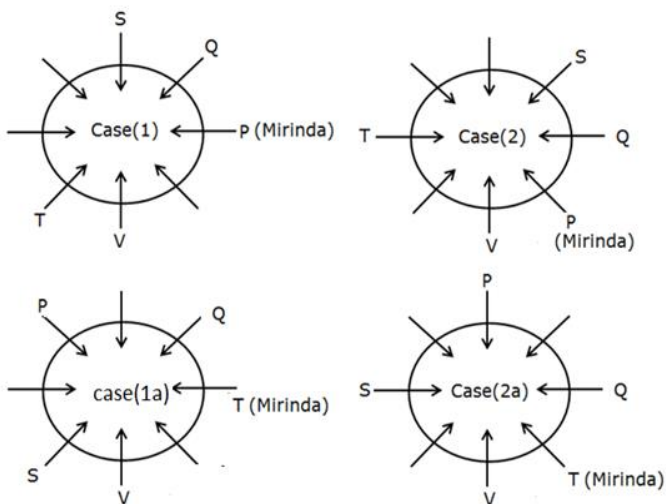

U likes Limca but is not an immediate neighbor of both P and T.

So case 1a is eliminated.

The one who likes Fanta sits opposite to U.

Neither R nor Q likes Fanta.

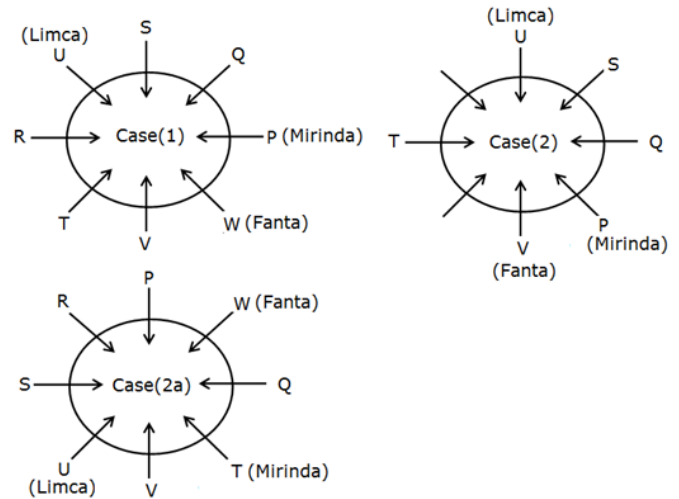

W and the one who likes Dew sit adjacent to each other.

The person who likes Pepsi sits adjacent to both one who likes Coca-cola and the one who likes Fruity.

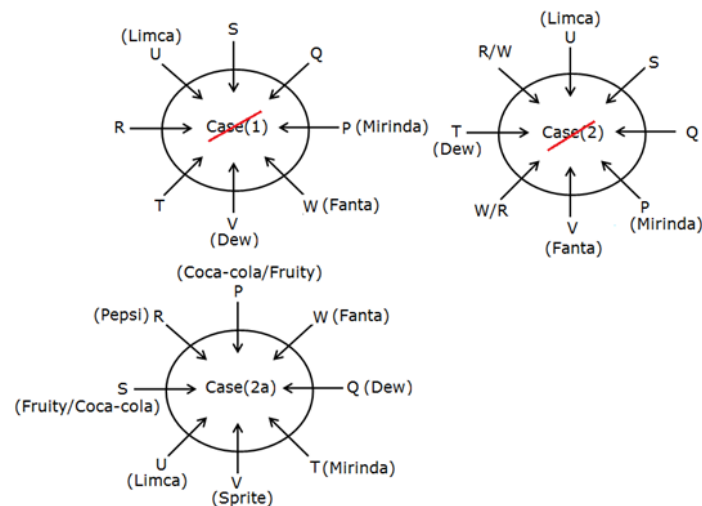

We cannot fix the position of the person who likes Pepsi exactly adjacent to both the ones who like Coca-cola and Fruity in case (1) and case (2). So this case is eliminated.

156) Answer: D

157) Answer: B

Top Expected Puzzle and Seating Questions for Upcoming Bank Prelims Exams 2021 (English Version)

158) Answer: A

159) Answer: E

160) Answer: C

Direction (161-165): Answer the questions based on the information given below.

Eight people viz. E, F, G, H, I, J, K, and L are sitting one at each of the corners and one each in the middle of the sides of a square table facing towards the centre. Each person likes different fruits i.e. Apple, Banana, Grapes, Kiwi, Mango, Papaya, Pineapple, and Watermelon. The person with the consecutive alphabetical names is not adjacent to each other (i.e. F is neither adjacent to E nor G). All the information is not necessarily in the same order.

The one who likes Banana sits third to the right of L who sits in the middle of the table. Only one person sits between H and L. Neither L nor H likes Watermelon. K sits second to the right of the one, who likes Watermelon; both are neither adjacent to H nor L. J, who likes Kiwi, sits second to the right of F, who doesn't sit adjacent to K. One who likes Apple sits second to the left of the one, who likes Mango. Neither K nor H likes Apple. Neither L nor H likes Pineapple. The one who likes Papaya sits adjacent to neither J nor L. I sits neither adjacent to H nor J. E neither likes Watermelon nor Mango.

161. Which of the following statement(s) is/are true?

A. G sits third to the right of the one who likes Mango.

B. The one who likes Apple sits to the immediate left of the person who likes Papaya.

C. E sits second to the right of the person who likes Watermelon.

D. Both a and c

E. Both a and b

162. Four of the following are alike in a certain way and hence form a group. Find the one that doesn't belong to that group.

A. L - Kiwi

B. G - Banana

C. K - Apple

D. H - Grapes

E. J - Watermelon

163. Who sits third to the right of the one who likes Banana?

A. The one who likes Grapes

B. J

C. The one who likes Papaya.

D. E

E. None of these

164. What is the position of J with respect to the one who likes Pineapple?

A. Third to the right

B. Immediate left

C. Second to the left

D. Third to the left

E. Immediate right

Top Expected Puzzle and Seating Questions for Upcoming Bank Prelims Exams 2021
(English Version)

165. Who among the following person likes Apple?

- A. The one who sits second to the left of the person who likes Grapes
- B. The one who sits second to the right of the person who likes Kiwi
- C. The one who sits to the immediate left of the person who likes Papaya
- D. The one who sits to the immediate left of the person who likes Mango
- E. None of these

Explanation

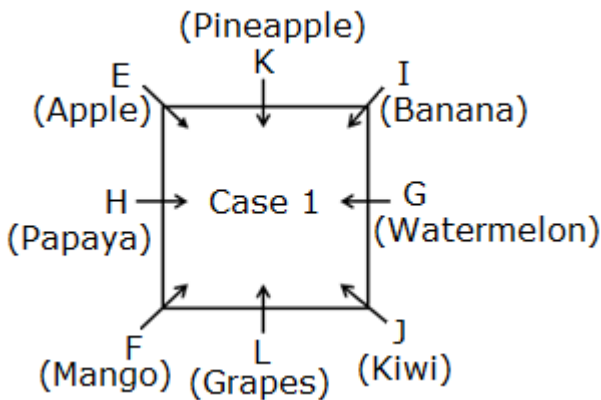

1. The one who likes Banana sits third to the right of L who sits in the middle of the table. Only one person sits between H and L.

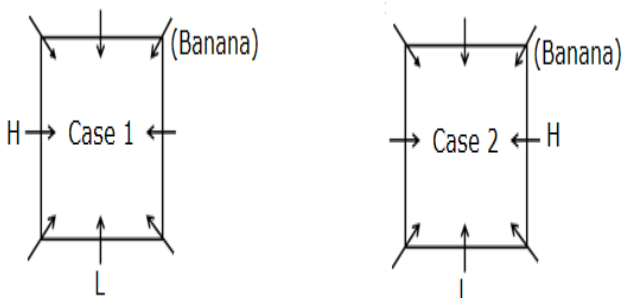

- 2. K sits second to the right of the one, who likes Watermelon, both are neither adjacent to H nor L.
- 3. Neither L nor H likes Watermelon.

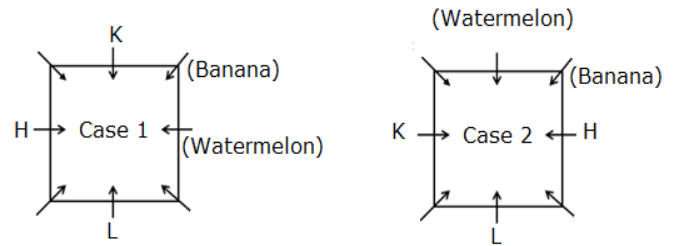

- 4. J, who likes Kiwi, sits second to the right of F, who doesn't sit adjacent to K.
- Thus, case (2) get eliminated.

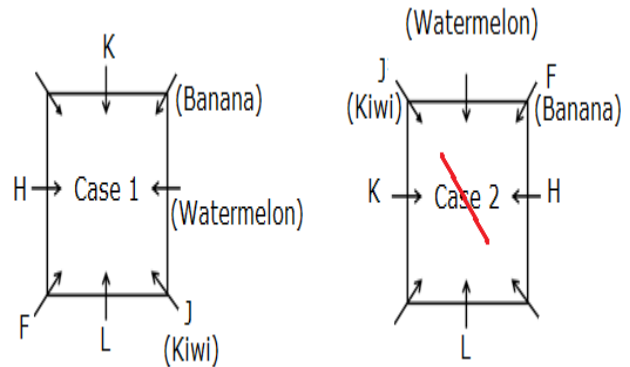

- 5. One who likes Apple sits second to the left of the one, who likes Mango. Neither K nor H likes Apple.

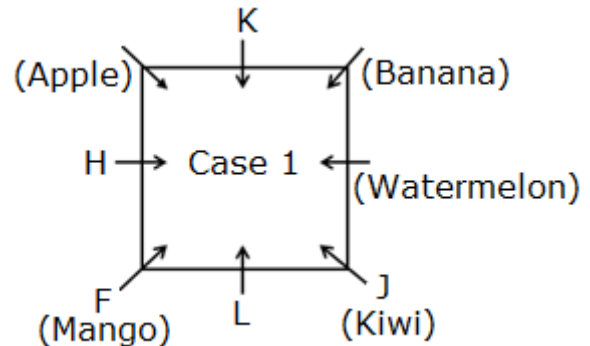

- 6. Neither L nor H likes Pineapple. The one who likes Papaya sits adjacent to neither J nor L.

Top Expected Puzzle and Seating Questions for Upcoming Bank Prelims Exams 2021
(English Version)

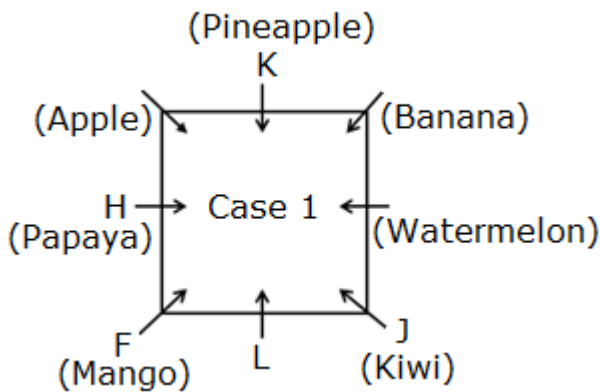

7. I sits neither adjacent to H nor J. E neither likes Watermelon nor Mango.

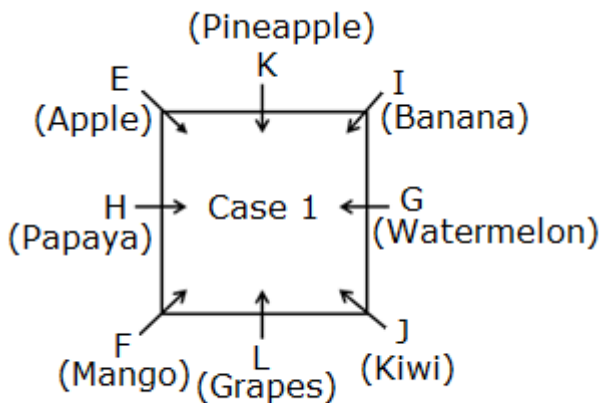

- 161) Answer: E
- 162) Answer: D
- 163) Answer: C
- 164) Answer: D
- 165) Answer: C

Direction (166-170): Answer the questions based on the information given below.

Eight persons viz. M, N, O, P, Q, R, S and T are seated in a square table such that all of them are facing towards the center, but not necessarily in the same order. Four persons sit at the corners while four persons sit in the middle of the four sides. The consecutive

alphabetically named person doesn't sit adjacent to each other.

M sits three persons away from N who sits to the immediate right of Q. R sits third to the left of Q and sits at the corner. S sits to the immediate left of P. Neither P nor T sits adjacent to R.

166. Who among the following person sits to the immediate right of R?

- A.M
- B.O
- C.Q
- D.S
- E.None of these

167. How many persons sit between N and T when counted from the left of N?

- A.1
- B.2
- C.3
- D.More than three
- E.None

168. What is the position of S with respect to M?

- A.Second to the right
- B.Third to the right
- C.Immediate left
- D.Second to the left
- E.None of these

169. If P is related to O and R is related to Q in a certain way, then who among the following person is related to T?

Top Expected Puzzle and Seating Questions for Upcoming Bank Prelims Exams 2021
(English Version)

- A.N
- B.Q
- C.M
- D.O
- E.P

170. If all the persons are made to sit in alphabetical order in clockwise direction Starting from M, then how many persons remain unchanged in their position, excluding M?

- A.None
- B.1
- C.2
- D.3
- E.More than three

Explanation

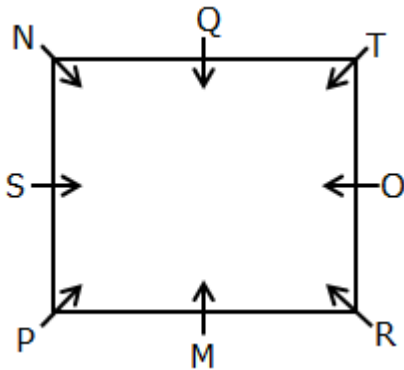

1. M sits three persons away from N who sits to the immediate right of Q. R sits third to the left of Q and sits at the corner.

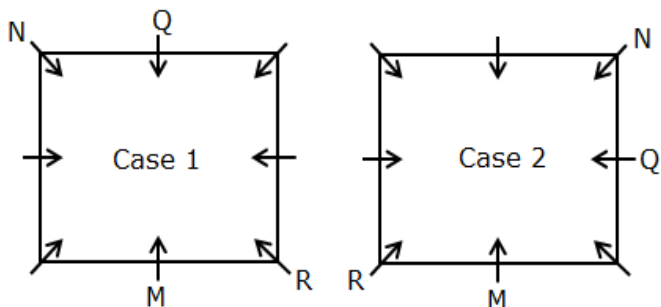

- 2. S sits to the immediate left of P.
- 3. Neither P nor T sits adjacent to R.
- 4. The consecutive alphabetically named person doesn't sit adjacent to each other Hence, case 2 gets eliminated.

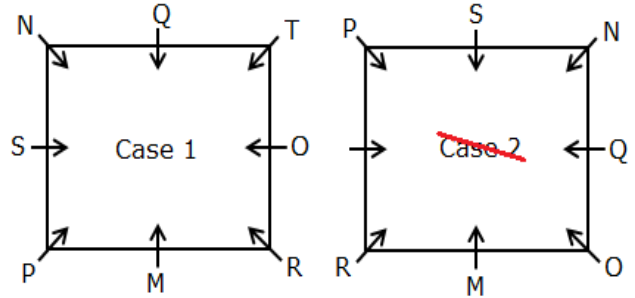

- 166) Answer: B
- 167) Answer: A
- 168) Answer: D
- 169) Answer: C
- 170) Answer: B

Direction (171-175): Study the following information carefully and answer the question below. (easy)

Ten persons A, B, C, D, E, F, G, H, I and J are sitting around a rectangular table in such a way that four persons sit at the corner of the table while other four sit on the longer side such that two on each side and remaining two sit on the smaller side such that one on each side. All are facing the centre of the table.

J sits 3rd to the right of E. Both the immediate neighbours of E either sit at the corner or sit at the sides of the table. Immediate neighbours of A face the immediate neighbours of E. G sits immediate left of C. Two persons sit between H

Top Expected Puzzle and Seating Questions for Upcoming Bank Prelims Exams 2021
(English Version)

and F. B is an immediate neighbour of both D and G. I doesn't sit adjacent to F.

171. How many persons sit between D and I when counted from the right of I?

- A.Four
- B.Three
- C.Five
- D.Six
- E.Two

172. Who among the following faces C?

- A.F
- B.H
- C.I
- D.J
- E.B

173. Find the odd one out.

- A.AD
- B.IJ
- C.CG
- D.EH
- E.FA

174. Which of the following statements is true?

- I). C is an immediate neighbour of E.
- II). H sits two places away from J.
- III). B sits at the corner.

- A.Only I
- B.Only III
- C.Only II
- D.Both I and II

E.All are true

175. If all the persons sit according to the alphabetical order starting from A in anticlockwise direction then the position of how many persons will remain unchanged (excluding A)?

- A.Three
- B.One
- C.Two
- D.Four
- E.None

Explanation

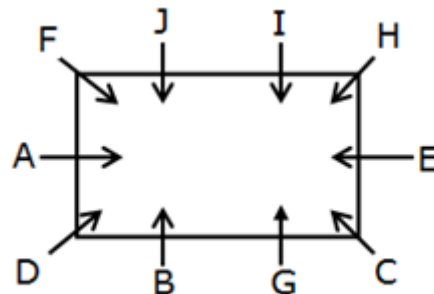

J is sitting 3rd to the right of E. Immediate neighbors of E either sit at the corner or sit at the sides of the table.

Here we get three possibilities.

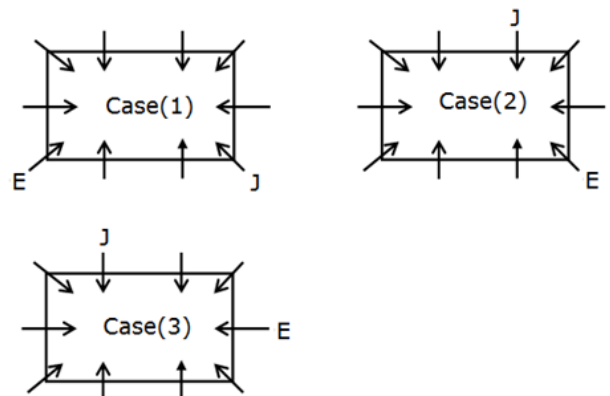

Immediate neighbours of A faces the immediate neighbors of E.

Top Expected Puzzle and Seating Questions for Upcoming Bank Prelims Exams 2021
(English Version)

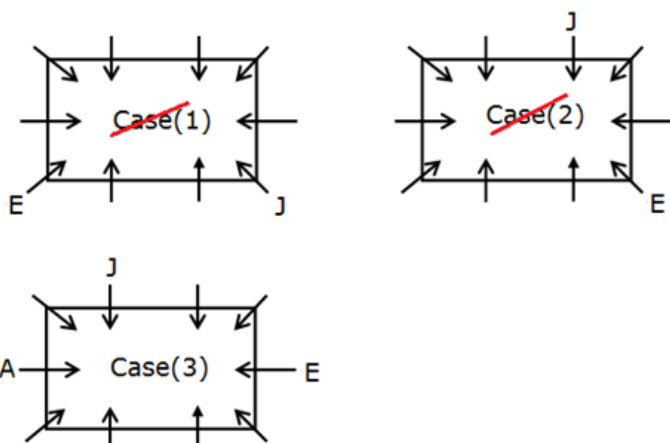

We cannot fix the position of A in case (1) and case (2). So these cases are eliminated.

G is sitting immediate left of C. B is an immediate neighbour of both D and G. Two persons sit between H and F. I doesn't sit adjacent to F.

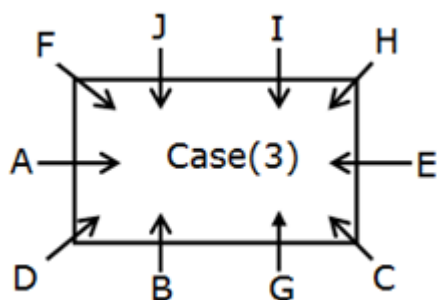

- 171) Answer: B
- 172) Answer: A
- 173) Answer: C
- 174) Answer: D
- 175) Answer: E

Direction (176-180): Study the following information carefully and answer the questions given below.

Six persons viz. M, N, O, P, Q and R are seated on a rectangular table such that two persons sit on each long side while one person sits on each

short side and all of them are facing towards the center. Each person like different fruits viz. Apple, Berry, Grapes, Mango, Peach and Pine. All the information is not necessarily in the same order.

N sits second to the right of the one who likes Grapes. The one who likes Pine is neither adjacent to N nor the one who likes Grapes. M sits third to the left of the one who likes Pine. N and M are not sitting on the same side. O sits on one of the shorter sides. The one who likes Apple sits second to the left of O. The one who likes Peach faces the one who likes Mango who doesn't sit adjacent to the one who likes Grapes. R sits to the immediate left of P. Q doesn't like Grapes.

176. Who among the following person likes Peach?

- A.P
- B.O
- C.R
- D.R
- E.None of these

177. Who among the following person sits second to the left of the one who likes Apple?

- A.The one who likes Grapes
- B.M
- C.The one who likes Berry
- D.R
- E.None of these

Top Expected Puzzle and Seating Questions for Upcoming Bank Prelims Exams 2021
(English Version)

178. The number of persons sits from the right of ____ to the one who likes Apple is the same as the number of persons sits from the left of ____ to the one who likes Berry respectively.

- A.P, O
- B.O, N
- C.R, Q
- D.Q, P
- E.None of these

179. Which of the following fruit was liked by N?

- A.Berry
- B.Apple
- C.Mango
- D.Pine
- E.None of these

180. If R is related to Mango and M is related to Peach in a certain way, then who among the following is related to Apple?

- A.Q
- B.P
- C.R
- D.M
- E.None of these

Explanation

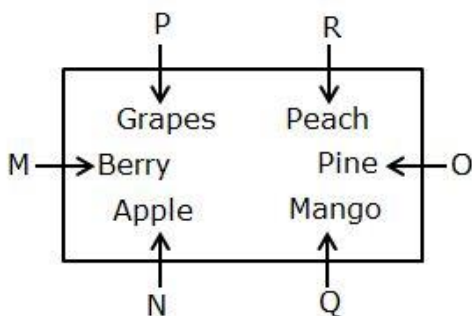

1. N sits second to the right of the one who likes Grapes. The one who likes Pine is neither adjacent to N nor the one who likes Grapes.

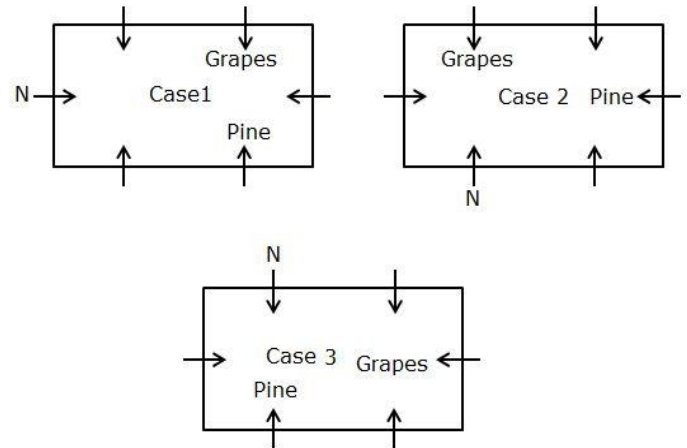

2. M sits third to the left of the one who likes Pine. N and M are not sitting on the same side. O sits on one of the shorter sides. The one who likes Apple sits second to the left of O.

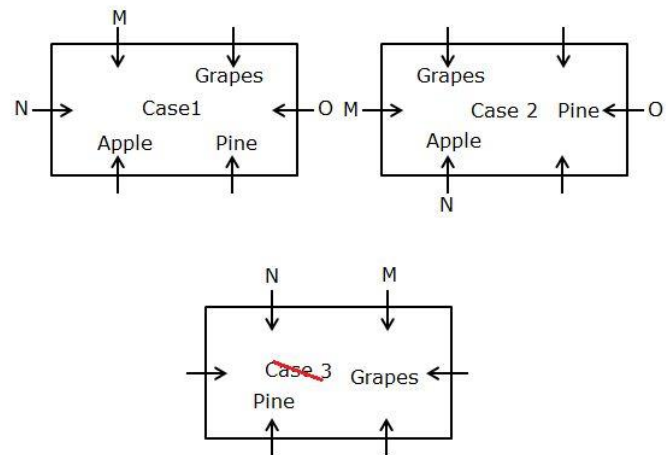

3. The one who likes Peach faces the one who likes Mango who doesn't sit adjacent to the one who likes Grapes. R sits to the immediate left of P. Q doesn't like Grapes. Hence, case 1 gets eliminated.

Top Expected Puzzle and Seating Questions for Upcoming Bank Prelims Exams 2021
(English Version)

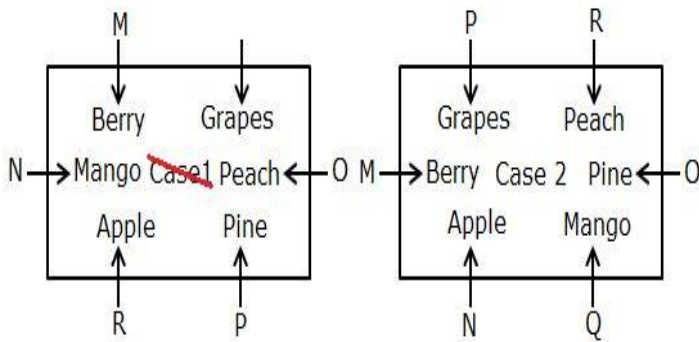

176) Answer: C

177) Answer: A

178) Answer: D

179) Answer: B

180) Answer: E

Direction (181-185): Answer the questions based on the information given below.

Six persons viz. A, B, C, D, E and F are seated in a triangular table such that One person sits at each corner and one person sits at middle of the each edges and all of them are facing towards the center, but not necessarily in the same order. Each of them orders different dishes viz. Dosa, Idly, Poori, Pongal, Roti and Vadai, but not necessarily in the same order. Not more than one dish was ordered by the same person. A sits two persons away from F who sits to the immediate left of the one who orders Dosa. The one who faces F orders Idly. E sits to the immediate right of B who neither orders Dosa nor Idly. The one who orders Poori faces the one who orders Pongal and sits to the immediate left of D. B doesn't order Vadai. The one who orders Roti sits in the middle of the edge.

181. Who among the following person orders Dosa?

- A.E
- B.D
- C.A
- D.C
- E.None of these

182. How many persons sit between E and the one who orders Idly, when counted from the right of E?

- A.One
- B.Two
- C.Three
- D.More than three
- E.None

183. Which of the following dish was ordered by B?

- A.Vadai
- B.Roti
- C.Poori
- D.Pongal
- E.None of these

184. What is the position of the one who orders Vadai with respect to A?

- A.Second to the left
- B.Same person
- C.Immediate right
- D.Third to the left
- E.None of these

Top Expected Puzzle and Seating Questions for Upcoming Bank Prelims Exams 2021
(English Version)

185. If D is related to Roti and F is related to Dosa in a certain way, then who among the following person is related to Pongal?

- A.F
- B.E
- C.B
- D.C
- E.None of these

Explanation

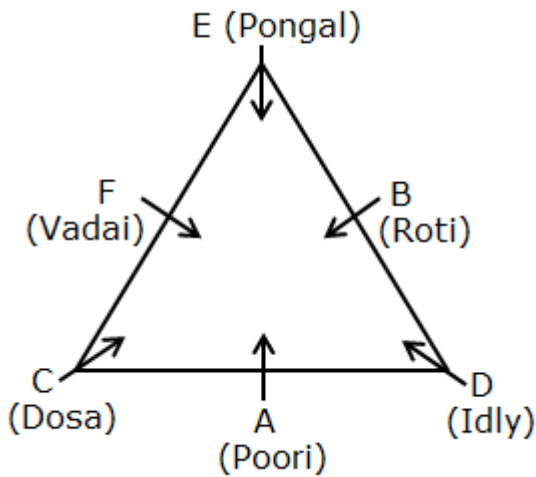

- 1) A sits two persons away from F who sits to the immediate left of the one who orders Dosa.
- 2) The one who faces F orders Idly.

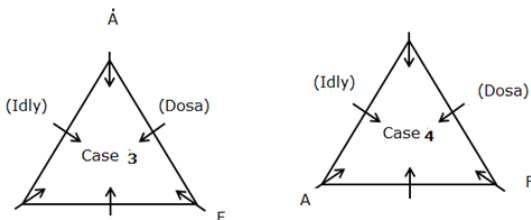
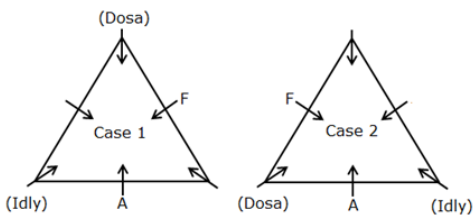

- 3) E sits to the immediate right of B who neither orders Dosa nor Idly.

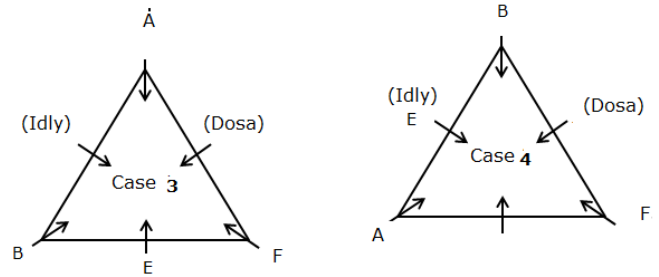
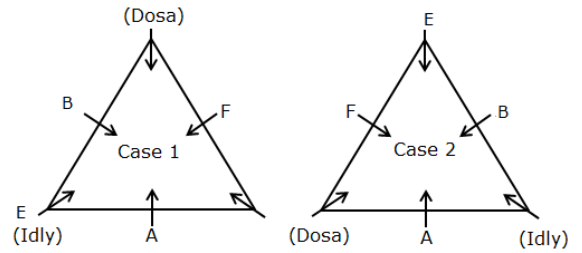

- 4) The one who orders Poori faces the one who orders Pongal and sits to the immediate left of D. B doesn't order Vadai.
- 5) The one who orders Roti sits in the middle of the edge.
- 6) Hence, case 1, 3 and 4 gets eliminated. Case 2 is the final arrangement

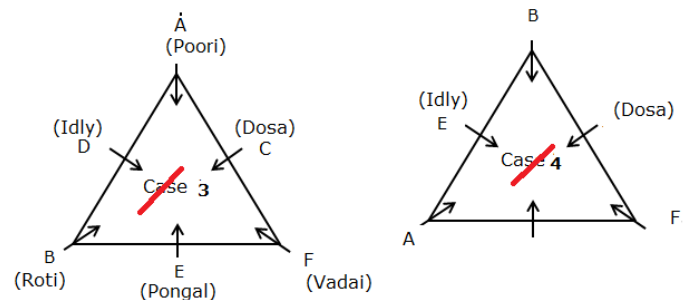
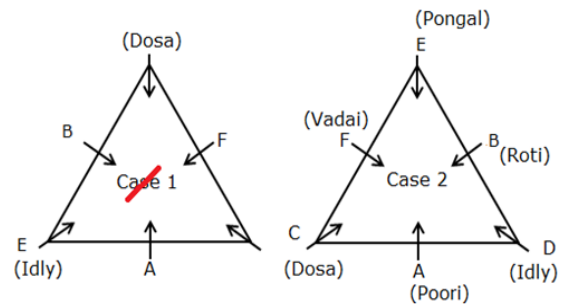

181) Answer: D

182) Answer: C

Top Expected Puzzle and Seating Questions for Upcoming Bank Prelims Exams 2021 (English Version)

183) Answer: B

184) Answer: A

185) Answer: C

Direction (186-190): Answer the questions based on the information given below.

Nine persons viz. A, B, C, D, E, F, G, H and I are sitting in a triangular table such that all of them are facing towards the center, but not necessarily in the same order. Two persons sit at each of the sides and one person sits at each of the corners.

Only three persons sit between G and I where both don't sit at any of the corners. F sits second to the right of G. The number of persons between F and G is same as the number of persons between G and A, who sits to the immediate right of H. Only two persons sit between H and B who sits second to the right of C. D sits third to the left of E where both sit at the corners.

186. Who among the following person sits second to the right of B?

- A.G
- B.E
- C.D
- D.H
- E.None of these

187. How many persons sit between C and E when counted from the right of E?

- A.1
- B.2
- C.3

D.More than three

E.None

188. Four of the following five are alike in a certain way and hence form a group. Find the one that doesn't belong to that group.

- A.G
- B.I
- C.H
- D.F
- E.C

189. What is the position of B with respect to I?

- A.Second to the left
- B.Immediate left
- C.Third to the right
- D.Second to the right
- E.None of these

190. Who among the following person sits third to the left of F?

- A.G
- B.A
- C.H
- D.D
- E.None of these

Explanation

Top Expected Puzzle and Seating Questions for Upcoming Bank Prelims Exams 2021
(English Version)

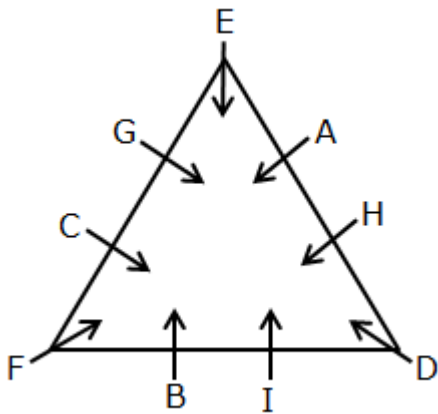

1. Only three persons sit between G and I where both don't sit at any of the corners. F sits second to the right of G.

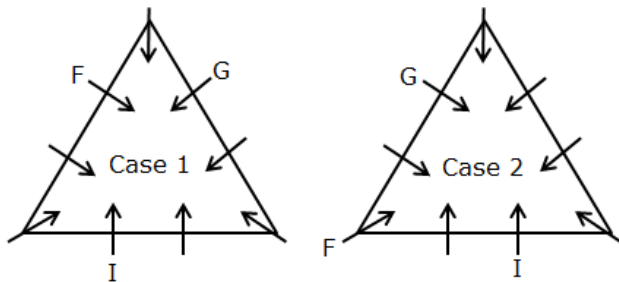

2. The number of persons between F and G is same as the number of persons between G and A, who sits to the immediate right of H.

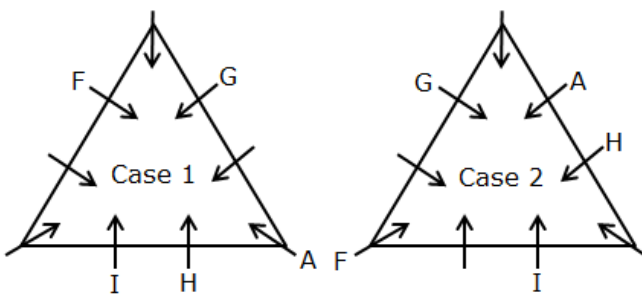

3. Only two persons sit between H and B who sits second to the right of C.
4. D sits third to the left of E where both sit at the corners.
5. Hence, case 1 gets eliminated.

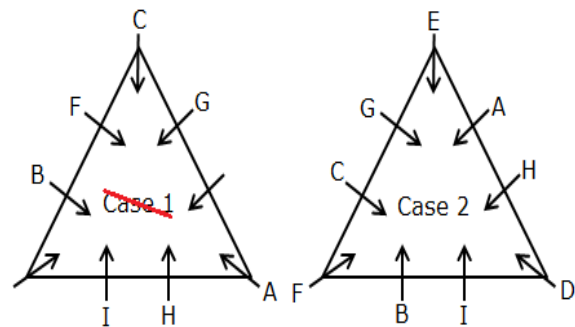

- 186) Answer: C
187) Answer: A
188) Answer: D
189) Answer: B
190) Answer: E

Direction (191-195): Study the following information carefully and answer the questions given below.

Six stationary items viz., Eraser, Marker, Note, Pen, Pencil, and Scale are kept on a hexagonal table such that all the items are facing inside the table, but not necessarily in the same order. All the items are placed at the corners of the table. Only one item was placed between Marker and Eraser. The scale was placed exactly facing towards Marker. The position of Eraser from Scale is the same as the position of Marker from Pencil. The number of items between Scale and Pencil is the same as the number of items between Marker and Note. The pen was not placed to the immediate right of the Marker.

191. Which of the following item is placed second to the left of the Pencil?

- A.Note
B.Scale

Top Expected Puzzle and Seating Questions for Upcoming Bank Prelims Exams 2021
(English Version)

- C. Pen
- D. Marker
- E. None of these

192. How many items are placed between Note and Scale when counted from the left of Scale?

- A. One
- B. Two
- C. Three
- D. More than three
- E. None

193. If Marker is related to Pen and Eraser is related to Pencil, then which of the following item is related to Note?

- A. Pen
- B. Scale
- C. Marker
- D. Eraser
- E. None of these

194. What is the position of Note with respect to Eraser?

- A. Second to the left
- B. Second to the right
- C. Third to the left
- D. Immediate right
- E. None of these

195. If all the items are placed in alphabetical order in the clockwise direction with respect to Eraser, then how many items remain unchanged in their position, excluding Eraser?

- A. One
- B. Two
- C. Three
- D. More than three
- E. None

Explanation

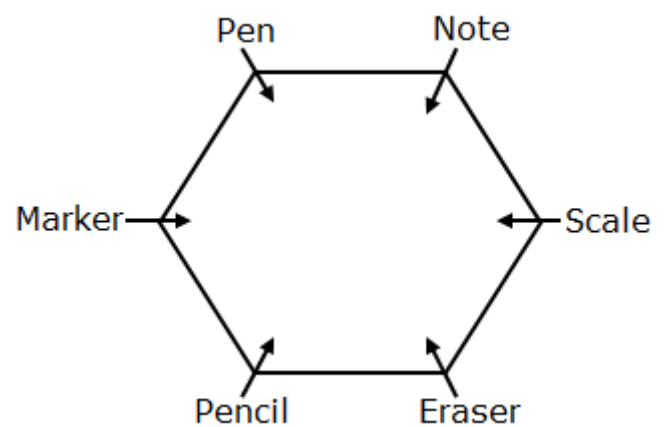

1. Only one item was placed between Marker and Eraser. The scale was placed exactly facing towards Marker. The position of Eraser from Scale is the same as the position of Marker from Pencil.

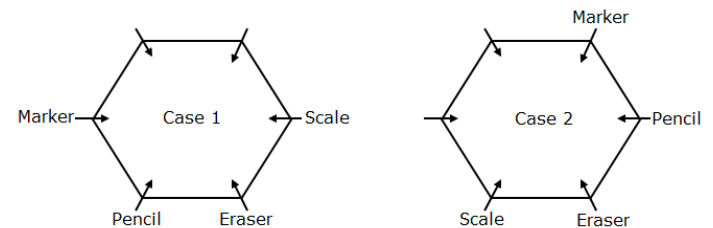

2. The number of items between Scale and Pencil is the same as the number of items between Marker and Note. The pen was not placed to the immediate right of Marker. Hence, case 2 gets eliminated.

Top Expected Puzzle and Seating Questions for Upcoming Bank Prelims Exams 2021
(English Version)

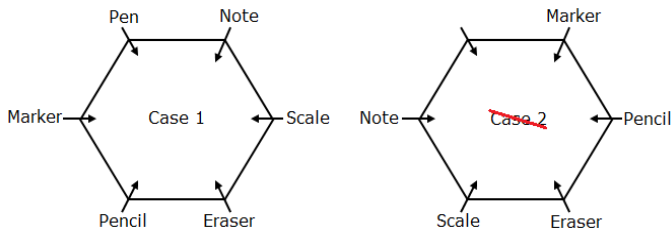

191) Answer: C

192) Answer: D

193) Answer: A

194) Answer: B

195) Answer: B

Direction (196-200): Answer the questions based on the information given below.

Twelve persons viz. A, B, C, D, E, F, G, H, I, J, K and L are standing on the circumference of the hexagonal platform such that six persons are standing on the corners and faces away from the center while six persons are standing on the sides and faces towards the center, but not necessarily in the same order.

D stands fourth to the right of H who is third to the left of E. B stands second to the right of E who is three persons away from K. G stands to the immediate left of K and is exactly opposite to C. A faces towards the center and is to the immediate right of F. L stands second to the right of I and third to the right of J who doesn't stand adjacent to A.

196. Who among the following person stands second to the left of C?

A.F

B.A

C.J

D.K

E.E

197. What is the position of L with respect to B?

A.Immediate left

B.Third to the left

C.Exactly opposite

D.Immediate right

E.Third to the right

198. Who among the following person stands third to the left of the one who stands exactly opposite to F?

A.G

B.H

C.C

D.B

E.L

199. How many persons stand between C and A when counted from the right of C?

A.3

B.4

C.5

D.7

E.6

200. If E is related to K and A is related to H in a certain way, then who among the following person is related to C?

A.A

B.G

C.J

Top Expected Puzzle and Seating Questions for Upcoming Bank Prelims Exams 2021
(English Version)

D.B

E.I

Explanation

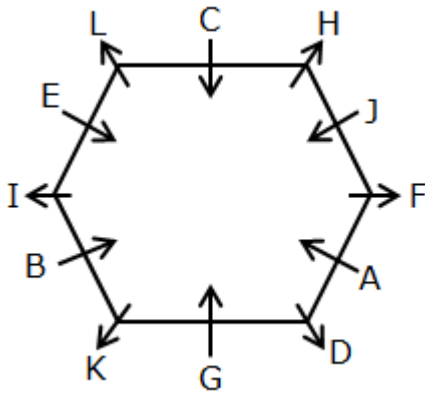

1. D stands fourth to the right of H who is third to the left of E. B stands second to the right of E who is three persons away from K.

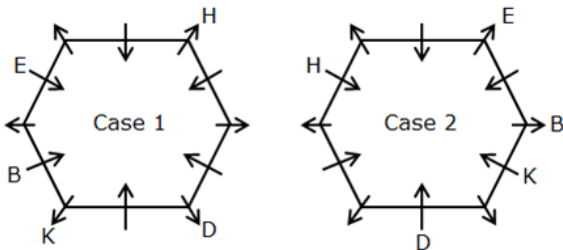

2. G stands to the immediate left of K and is exactly opposite to C. A faces towards the center and is to the immediate right of F.

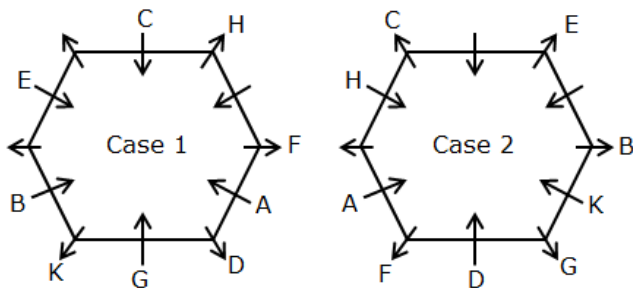

3. L stands second to the right of I and third to the right of J who doesn't stand adjacent to A. Hence, case 2 gets eliminated.

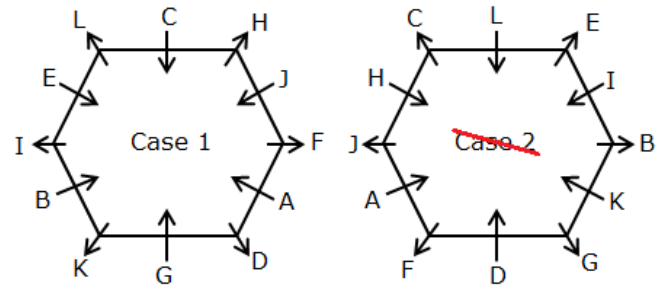

196) Answer: C

197) Answer: B

198) Answer: A

199) Answer: D

200) Answer: E

Direction (201-205): Study the following information carefully and answer the questions given below.

Eight persons viz. L, M, N, O, P, Q, R and S are sitting on a straight line such that all of them are facing towards the north, but not necessarily in the same order. The consecutive alphabetically named person doesn't sit adjacent to each other.

Only three persons sit between O and S where neither of them sits at the end of the row. M sits second to the right of O. The number of persons sit to the right of M is the same as the number of persons sit to the left of Q, who sits second to the left of P. N sits neither adjacent to P nor S.

201. Who among the following pairs of persons sit at the end of the row?

A.R, N

B.N, L

C.R, L

D.S, N

Top Expected Puzzle and Seating Questions for Upcoming Bank Prelims Exams 2021
(English Version)

E. None of these

202. If all the persons are made to sit in alphabetical order from left to right, then how many persons remain unchanged in their position?

- A. One
- B. Two
- C. Three
- D. More than three
- E. None

203. If O is related to Q and S is related to L in a certain way, then who among the following persons is related to R?

- A. N
- B. P
- C. O
- D. M
- E. None of these

204. What is the position of P with respect to R?

- A. Second to the right
- B. Immediate right
- C. Third to the left
- D. Fourth to the right
- E. None of these

205. The number of persons sit to the left of S is the same as to the right of ____.

- A. N
- B. L
- C. R

D. O

E. None of these

Explanation



1. Only three persons sit between O and S where neither of them sits at the end of the row. M sits second to the right of O.

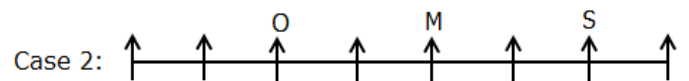
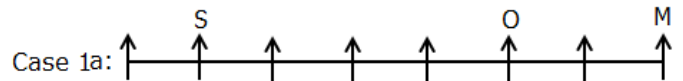

2. The number of persons sit to the right of M is the same as the number of persons sit to the left of Q, who sits second to the left of P. N sits neither adjacent to P nor S. The consecutive alphabetically named person doesn't sit adjacent to each other. Hence, cases 1 and 1a get eliminated.

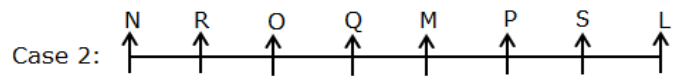
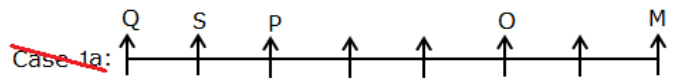

201) Answer: B

202) Answer: E

203) Answer: A

204) Answer: D

205) Answer: C

Top Expected Puzzle and Seating Questions for Upcoming Bank Prelims Exams 2021
(English Version)

Direction (206-210): Study the following information carefully and answer the questions given below.

Seven persons viz. F, G, H, I, J, K and L are sitting on a linear row such that all of them are facing towards north. Each person is using different brand pencils viz. Apsara, Camel, Camlin, Cello, Doms, Flair and HB. All the information is not necessarily in the same order. Only four persons sit between the one who uses Apsara pencil and G, who doesn't sit at any of the ends. K sits third from the right end and is to the immediate left of the one who uses Cello. The one who uses Doms sits second to the left of K. The one who uses HB is adjacent to the one who uses Doms but not adjacent to K. I sits second to the right of the one who uses HB. Neither K nor I use Camel. F sits adjacent to L and the one who uses Flair. More than one person sits between H and J who doesn't use Apsara.

206. Who among the following person uses Camlin?

- A.H
- B.J
- C.F
- D.K
- E.None of these

207. What is the position of H with respect to F?

- A.Fourth to the right
- B.Second to the left

- C.Fifth to the right
- D.Immediate left
- E.None of these

208. Who among the following sits third to the right of the one who uses Flair?

- A.H
- B.I
- C.J
- D.No such person
- E.None of these

209. Four of the following five are alike in a certain way and hence form a group. Find the one that doesn't belong to that group.

- A.H – Doms
- B.I – Cello
- C.F – Camlin
- D.K – Camel
- E.G – Flair

210. If all the persons are made to sit in alphabetical order from right to left, then who among the following sits third from the left end?

- A.The one using Camel
- B.The one using Camlin
- C.The one using Flair
- D.The one using Apsara
- E.None of these

Explanation

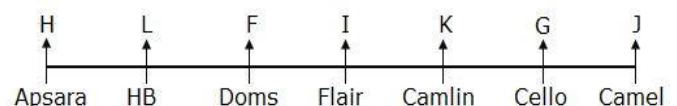

Top Expected Puzzle and Seating Questions for Upcoming Bank Prelims Exams 2021
(English Version)

1. Only four persons sit between the one who uses Apsara pencil and G, who doesn't sit at any of the ends. K sits third from the right end and is to the immediate left of the one who uses Cello.

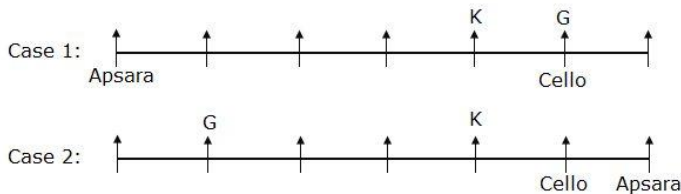

2. The one who uses Doms sits second to the left of K. The one who uses HB is adjacent to the one who uses Doms but not adjacent to K. I sits second to the right of the one who uses HB.

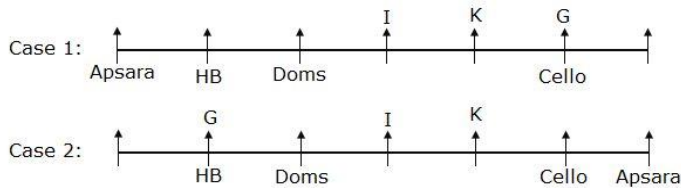

3. Neither K nor I use Camel. F sits adjacent to L and the one who uses Flair. More than one person sits between H and J who doesn't use Apsara. Hence, case 2 gets eliminated.

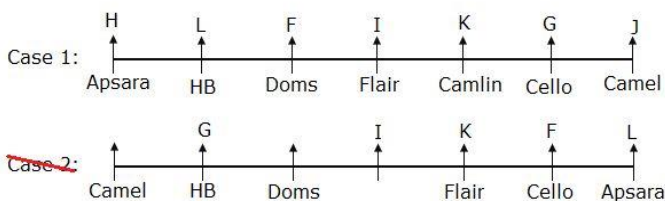

206) Answer: D

207) Answer: B

208) Answer: C

209) Answer: E

210) Answer: A

Direction (211-215): Study the following information carefully and answer the questions given below:

A certain number of persons are sitting in a linear row facing north direction. Four persons sit between V and I. U sits second to the right of I. Five persons sit between U and O. Number of persons who sit between I and O is equal to the number of persons who sit between C and V. K sits second to the right of C who sits left of O. Neither U nor J sits adjacent to C. J sits fifth to the left of M who sits second from V. L sits second to the left of O who sits exactly between L and D.

211. How many persons sit between J and L?

A.11

B.17

C.15

D.13

E. Other than the given option

212. Who sits fifth to the right of M?

I. The person who sits third to the right of I

II. The person who sits exactly between V and O

III. The Person who sits fourth to the left of L

A. Both I and II

B. Both II and III

C. Only III

D. All I, II and III

E. None of these

213. Which of the following statement is true?

A. Eight persons sit between K and M

B. C sits seventh to the left of V

C. More than five persons sit between I and L

Top Expected Puzzle and Seating Questions for Upcoming Bank Prelims Exams 2021
(English Version)

D.D sits third to the right of L
E.None is true.

214. The number of persons who sit to the left of M is same as the number of persons who sits to the right of ____?

- A.U
- B.V
- C.I
- D.M
- E.Other than the given option

215. How many persons are sitting in the linear row, if C and D are sitting at the ends?

- A.28
- B.27
- C.24
- D.22
- E.None of these

Explanation

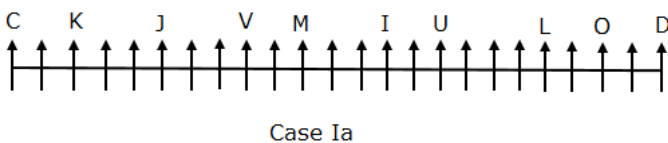

A certain number of persons are sitting in a linear row facing north direction.
Four persons sit between V and I. U sits second to the right of I.

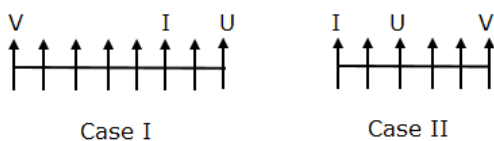

Five persons sit between U and O. Number of persons who sit between I and O is equal to the number of persons who sit between C and V.

K sits second to the right of C who sits left of O.
Neither U nor J sits adjacent to C.

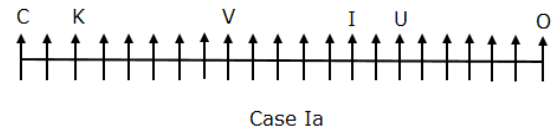
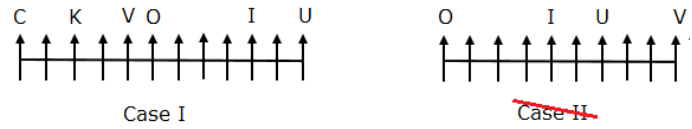

J sits fifth to the left of M who sits second from V. L sits second to the left of O who sits exactly between L and D. Neither U nor J sits adjacent to C.

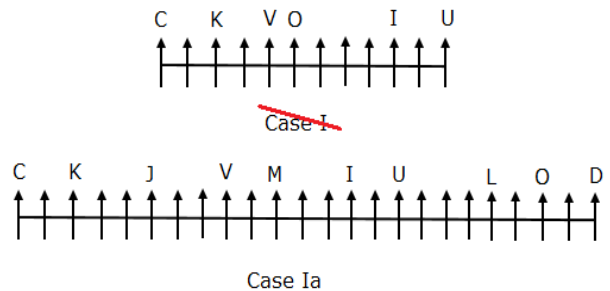

- 211) Answer: D
- 212) Answer: C
- 213) Answer: E
- 214) Answer: C
- 215) Answer: C

Direction (216-220): Study the following information carefully and answer the below questions

A certain number of persons are sitting in a linear row facing the north direction. G sits third to the right of the one who sits seventh to the left of V. Only one person is sitting between V and K. Six persons are sitting between G and Y. The number of persons is sitting between O and G is

Top Expected Puzzle and Seating Questions for Upcoming Bank Prelims Exams 2021
(English Version)

one less than between O and Y. The numbers of persons are sitting between K and O are the same as between O and T. Y does not sit to the right of K. M sits third to the right of the one who sits second to the right of V. The number of people who sits between K and M is one less than between X and T. X sits fourth to the right of L. X sits exactly between L and T. The number of persons is sitting to the right of L is the same as to the left of M. No one sits to the left of L.

216. How many persons are sitting in the row?

- A.30
- B.29
- C.28
- D.31
- E.32

217. Which of the following statement is true?

- I. Only two persons sit between K and M
 - II. Y sits to the left of T
 - III. Only three persons are sitting between G and V
- A.Only I
 - B.Both I and III
 - C.Only III
 - D.All I, II, and III
 - E.None of these

218. Four of the five among the following are similar in such a way to form a group, who

among the following doesn't belong to the group?

- A.LX
- B.YO
- C.XT
- D.GV
- E.VM

219. How many persons are sitting between K and T?

- A.17
- B.16
- C.18
- D.19
- E.15

220. In which of the following statement, the first person sits to the right of the second person?

- I. GY
 - II. XM
 - III. TL
- A.Both II and III
 - B.Only III
 - C.Both I and II
 - D.Only II
 - E.Both I and III

Explanation

Final Arrangement

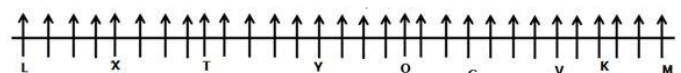

We have,

- G sits third to the right of the one who sits seventh to the left of V.

Top Expected Puzzle and Seating Questions for Upcoming Bank Prelims Exams 2021
(English Version)

- Only one person is sitting between V and K.

From the above condition, there are two possibilities.

Case1

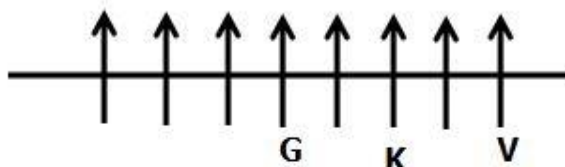

Case2

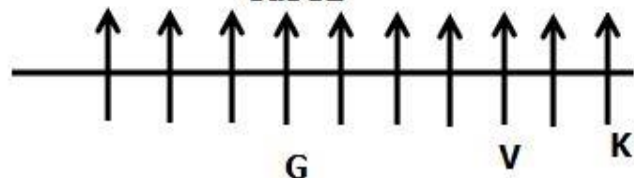

Again we have,

- Six persons are sitting between G and Y.
- The number of persons is sitting between O and G is one less than between O and Y.
- The number of persons is sitting between K and O is the same as between O and T.
- Y does not sit to the right of K.

Case1

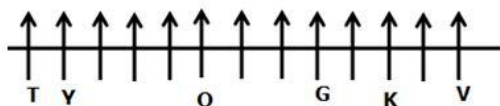

Case2

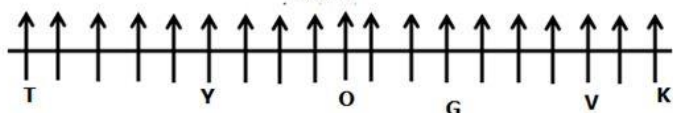

Again we have,

- M sits third to the right of the one who sits second to the right of V.

- The number of people sits between K and M is one less than between X and T.
- X sits fourth to the right of L.
- The number of persons is sitting to the right of L is the same as to the left of M.
- X sits exactly between L and T.
- No one sits to the left of L.

From the above condition, case1 gets eliminated. Case2 shows the final arrangement.

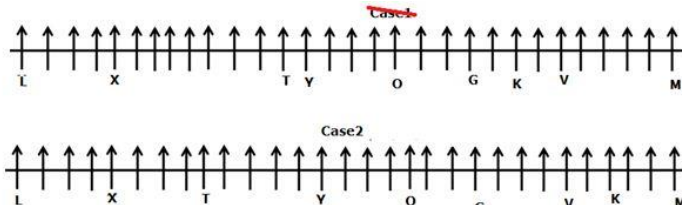

216) Answer: A

217) Answer: B

218) Answer: E

219) Answer: A

220) Answer: E

Direction (221-225): Study the following information carefully and answer the below questions

Twelve persons are sitting in the two parallel rows. In row1 A, B, C, D, E, and F are seated and faces south. In row2 P, Q, R, S, T, and U are seated and faces north. The persons sitting in row 1 are exactly opposite to persons sitting in row 2 and vice versa. All the information is not necessarily in the same order.

R sits third to the left of the one who faces E.

Only two persons are sitting between E and F. B sits second to the left of F. The number of persons to the left of R is the same as to the

**Top Expected Puzzle and Seating Questions for Upcoming Bank Prelims Exams 2021
(English Version)**

right of U. Only three persons are sitting between U and P. C and T sit opposite to each other. Neither C nor Q sits at the extreme ends of the row. D sits neither opposite to P nor U.

221. In which of the following, 1st person sits exactly between 2nd and 3rd person in the final arrangement?

- I). BCE
- II). QTU
- III).SPT
- A.Only II
- B.All I, II and III
- C.Only III
- D.Both I and II
- E.None of these

222. Four of the five among the following are similar in such a way to form a group, who among the following doesn't belong to the group?

- A.A
- B.The one who sits second to the left of Q
- C.The one who sits immediate right of U
- D.P
- E.The one who sits immediate left of E

223. Who among the following person sits second to the left of C?

- A.F
- B.The one who sits immediate left of A
- C.The one who faces U
- D.The one who sits second to the right of B
- E.D

224. Which of the following statements is/are false?

- I). Only one person is sitting between R and U
- II). B sits immediate left of C
- III). F and R sit opposite to each other
- A.Both I and III
- B.Only II
- C.Both I and II
- D.Only I
- E.None of the statements is false

225. Who among the following persons are adjacent to each other?

- A.BD
- B.QS
- C.FC
- D.AD
- E.RQ

Explanation

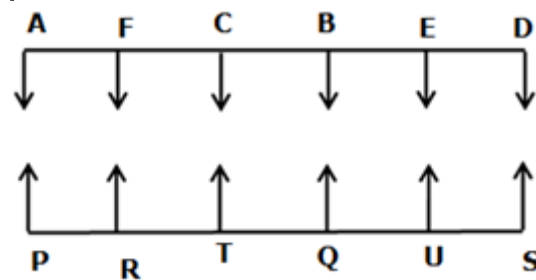

R sits third to the left of the one who faces E. Only two persons are sitting between E and F. From the above condition, there are three possibilities.

Top Expected Puzzle and Seating Questions for Upcoming Bank Prelims Exams 2021
(English Version)

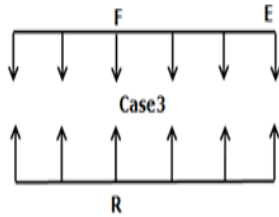
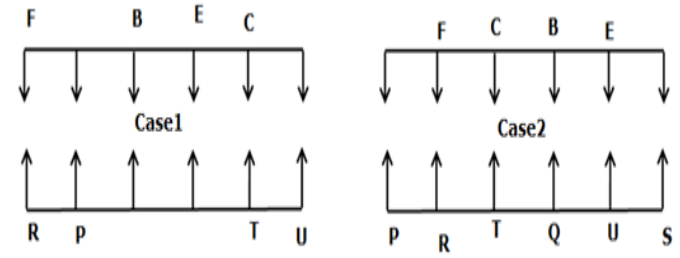
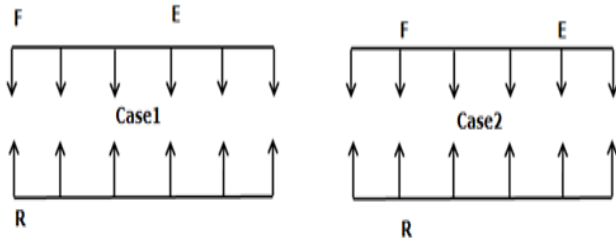

B sits second to the left of F.

The number of persons to the left of R is the same as to the right of U.

Only three persons are sitting between U and P.

From the above condition, case3 gets eliminated.

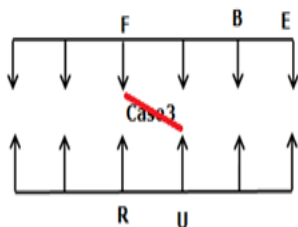
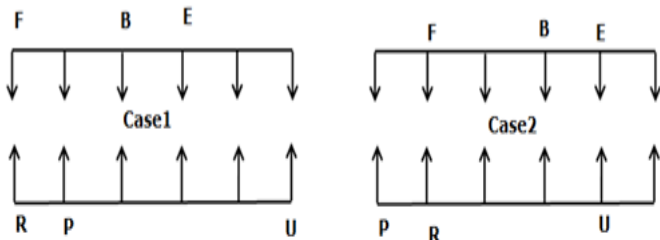

C and T sit opposite to each other.

Neither C nor Q sits at the extreme ends of the row.

D sits neither opposite to P nor U.

From the above condition, case1 gets eliminated. case2 shows the final arrangement.

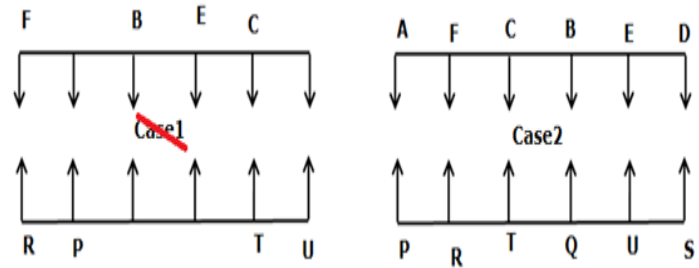

221) Answer: D

222) Answer: B

223) Answer: C

224) Answer: D

225) Answer: C

Direction (226-230): Study the following information carefully and answer the below questions.

In a laptop showroom, different brands of laptops are arranged in two parallel rows. In a row 1, Dell, HP, Lenovo, Acer and Asus are kept facing the south direction. In row 2, Microsoft, Samsung, Razer, Sony, and Apple are kept facing the north direction. All the information is not necessarily in the same order.

Dell laptop is kept opposite to the laptop which is kept third to the left of Razer. Microsoft and Sony are not kept adjacent to each other. HP

Top Expected Puzzle and Seating Questions for Upcoming Bank Prelims Exams 2021
(English Version)

laptop is kept immediately left of Lenovo. The number of laptops kept left of apple is the same as the right of Acer. Sony is not kept at the end of the row. Only one laptop is kept between Apple and Razer. Samsung is neither kept opposite to Asus nor Dell.

226. Which of the following brand is kept exactly between Asus and HP?

- A. Dell
- B. The laptop which is kept second to the right of Lenovo
- C. Acer
- D. The laptop which is kept opposite to Razer
- E. None of the above

227. Which of the following laptop is kept right of Sony?

- I) Razer
- II) Apple
- III) Samsung
- A. Both (I) and (II)
- B. Only (I)
- C. Both (I) and (III)
- D. Only (II)
- E. All (I), (II) and (III)

228. Which of the following laptop is kept opposite to Apple?

- A. Dell
- B. Acer
- C. Asus
- D. Lenovo

E. HP

229. What is the position of Microsoft laptop?

- A. Third from the right end
- B. First from the left end
- C. Second from the left end
- D. Fourth from the right end
- E. Fifth from the left end

230. If HP and Dell are interchanged their position, and then Dell and Sony are interchanged their position, then what is the position of Dell from the right end?

- A. First
- B. Second
- C. Third
- D. Fourth
- E. Fifth

Explanation

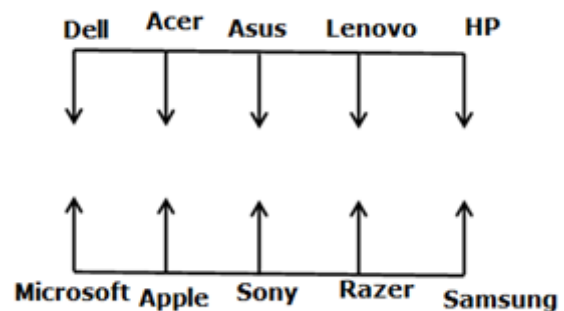

Dell laptop is kept opposite to the laptop which is kept third to the left of Razer.

Only one laptop is kept between Apple and Razer.

From there above condition, there are two possibilities.

Top Expected Puzzle and Seating Questions for Upcoming Bank Prelims Exams 2021
(English Version)

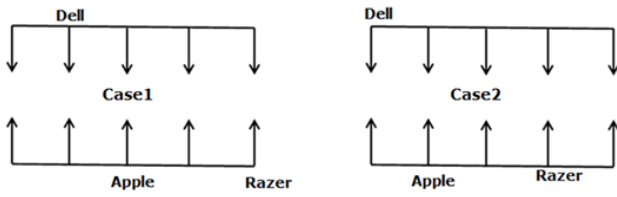

The number of laptops kept left of apple is the same as the right of Acer.

HP laptop is kept immediately left of Lenovo.

From the above condition, there are three possibilities.

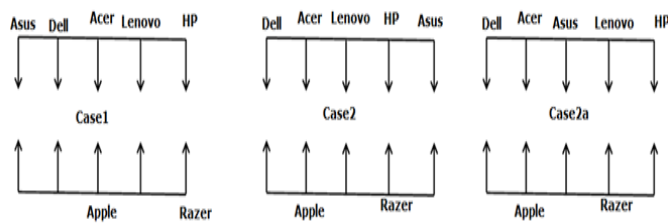

Samsung is neither kept opposite to Asus nor Dell.

Microsoft and Sony are not kept adjacent to each other.

From the above condition, case1 gets eliminated.

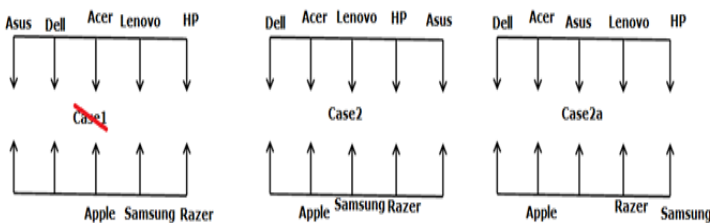

Sony is not kept at the end of the row.

From the above condition, case2 gets eliminated. Case2a shows the final arrangement.

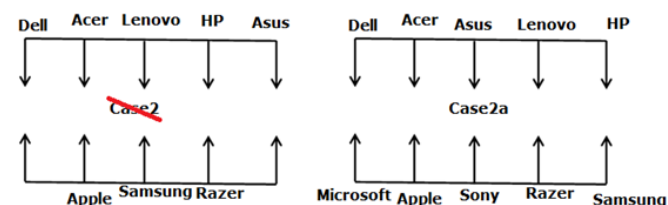

226) Answer: D

227) Answer: C

228) Answer: B

229) Answer: B

230) Answer: C

Direction (231-235): Study the following information carefully and answer the below questions.

A certain number of persons are sitting on the circular table facing the center. X sits fourth to the right of the one who sits second to the left of T. Only two persons are sitting between X and G. Only one person sits between A and the person who sits second to the left of X. The number of persons sitting between F and A is the same as between A and X. M sits fourth to the right of G but not to the left of F. At least two persons are sitting between F and G. The number of persons sitting between M and X is the same when counted from either left or right.

231. How many persons are sitting at the circular table?

- A. 13
- B. 17
- C. 16
- D. 14
- E. 15

232. If W sits exactly in the middle of M and G, then what is the position of W with respect to X?

- A. Fifth to the right
- B. Sixth to the right

Top Expected Puzzle and Seating Questions for Upcoming Bank Prelims Exams 2021
(English Version)

- C. Fifth to the left
- D. Third to the left
- E. Fourth to the left

233. How many persons are sitting between A and G?

- A. More than six
- B. Two
- C. Three
- D. Four
- E. Six

234. If G and X are interchanged their position and then X and M did the same then who among the following person sits third to the left of M?

- A. The one who sits second to the left of F
- B. The one who sits third to the right of A
- C. G
- D. X
- E. A

235. Who among the following person sits third to the left of the one who sits second to the left of T?

- A. G
- B. A
- C. The one who sits immediate right of F
- D. The one who sits third to the right of X
- E. None of the above

Explanation

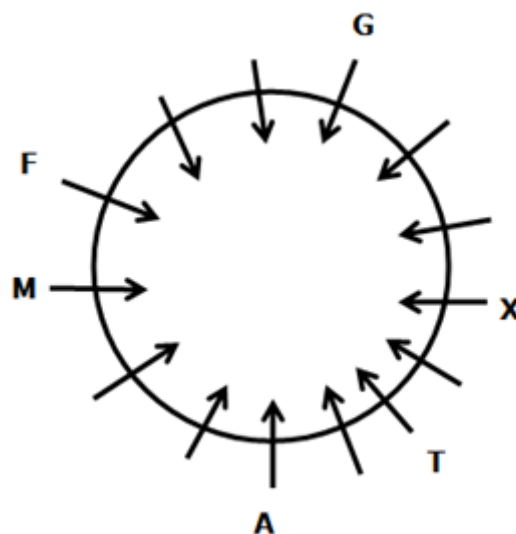

We have,

- X sits fourth to the right of the one who sits second to the left of T.
- Only two persons are sitting between X and G.

From the above condition, there are two possibilities.

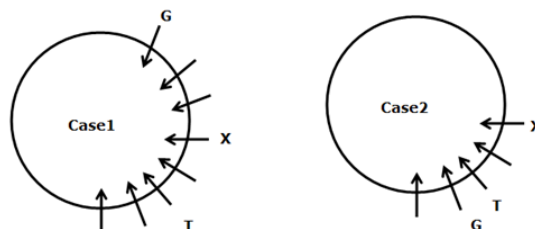

Again we have,

- The number of persons sitting between F and A is the same as between A and X.
- Only one person sits between A and the person who sits second to the left of X.

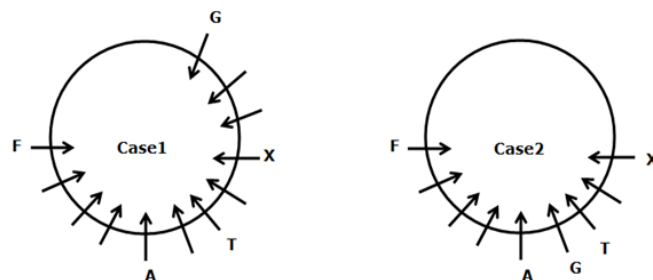

Top Expected Puzzle and Seating Questions for Upcoming Bank Prelims Exams 2021
(English Version)

Again we have,

- M sits fourth to the right of G but not to the left of F.
- At least two persons are sitting between F and G.
- The number of persons sitting between M and X is the same when counted from either left or right.

From the above condition, case2 gets eliminated. case1 shows the final arrangement.

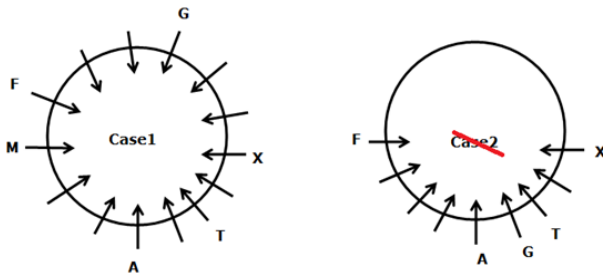

231) Answer: D

232) Answer: A

233) Answer: E

234) Answer: C

235) Answer: C

Direction (236-240): Study the following information carefully and answer the below questions:

A certain number of persons are sitting in a circular table facing the centre. Only one person sits between P and Q. T is an immediate neighbour of U but not an immediate neighbour of R. Only three persons sit between S and P when counted to the right of P. The number of persons sits between P and Q is same as between U and R. Only two persons sit between

R and S. U sits third to the left of P. Both R and P are not immediate neighbours.

236. Which of the following pair of persons are immediate neighbours?

- A.TR
- B.PR
- C.RQ
- D.UT
- E.SQ

237. Who among the following person sits between P and S when counts from the left of S?

- A.R
- B.U
- C.The one who sits second to the left of R
- D.T
- E.Q

238. Four of the following are alike in a certain way based on their positions in the seating arrangement and so form a group. Who among the one that does not belong to that group?

- A.QP
- B.SQ
- C.US
- D.UR
- E.PT

239. How many persons are sitting in the circular table?

- A.13

Top Expected Puzzle and Seating Questions for Upcoming Bank Prelims Exams 2021
(English Version)

- B.12
- C.11
- D.14
- E.None of these

240. Who sits second to the left of R?

- A.P
- B.The one who sits second to the right of Q
- C.S
- D.No one
- E.T

Explanation

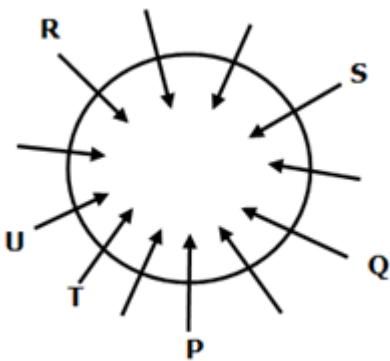

Only one person sits between P and Q.
U sits third to the left of P.
From the above condition, there are two possibilities.

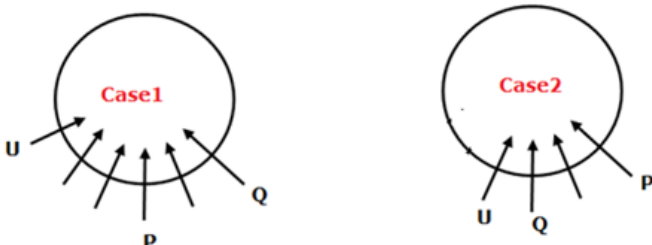

The numbers of persons sits between P and Q is same as between U and R.
R and P are not immediate neighbours.
Only two persons sit between R and S.

From the above condition, there are three possibilities.

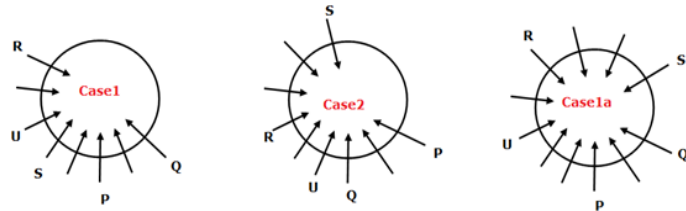

T is an immediate neighbour of U but not an immediate neighbour of R.

From the above condition, case1 and case2 get eliminated.

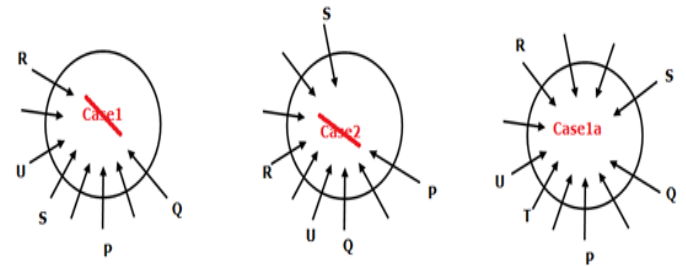

Only three persons are sitting between S and P when counted to the right of P.

From the above condition, case1a shows the final arrangement.

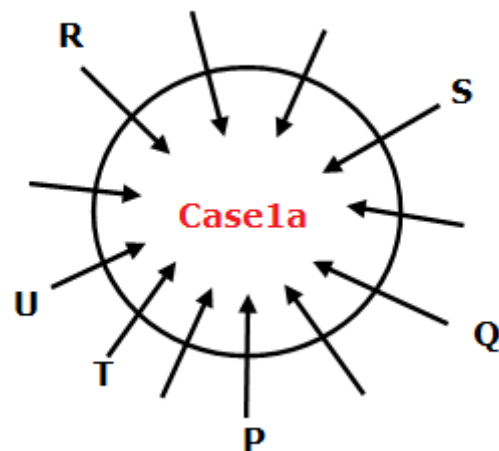

- 236) Answer: D
- 237) Answer: E
- 238) Answer: C

Top Expected Puzzle and Seating Questions for Upcoming Bank Prelims Exams 2021 (English Version)

239) Answer: B

240) Answer: D

Direction (241-245): Answer the questions based on the information given below.

Eight persons A, B, C, D, E, F, G and H are sitting around a circular table, but not necessarily in the same order. Some of them face towards the centre while others face outside. Not more than two persons face the same direction sit together.

The person who sits third to the left of A faces outside. G sits beside A and opposite to D, who faces towards the centre. E sits second to the left of D. C sits to the immediate right of E. H sits beside F, who sits third to the left of C who faces towards the centre. H doesn't sit second to the right of B, but both face the same direction. F faces the opposite direction to that of G.

241. Which of the following statement is true?

- A.D sits second to the right of C
- B.A and B face the opposite direction to each other
- C.F sits opposite to E
- D.H faces towards the centre
- E.All are false

242. Who among the following person sits third to the left of G?

- A.H
- B.The one who is immediate left of D
- C.F
- D.The one who is immediate right of E

E.None of these

243. Who among the following person sits opposite to C?

- A.B
- B.The one who sits immediate right of F
- C.D
- D.The one who sits second to the right of A
- E.None of these

244. How many persons face outside the centre?

- A.Five
- B.Three
- C.Four
- D.Two
- E.Six

245. How many persons sit between H and E, when counted from the left of H?

- A.Two
- B.Four
- C.Three
- D.Five
- E.None of these

Explanation

Top Expected Puzzle and Seating Questions for Upcoming Bank Prelims Exams 2021
(English Version)

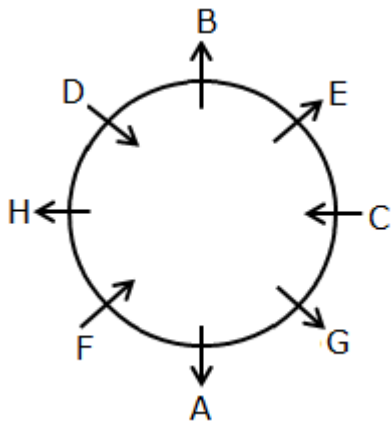

1. The person who sits third to the left of A faces outside. G sits beside A and opposite to D who faces towards the centre.

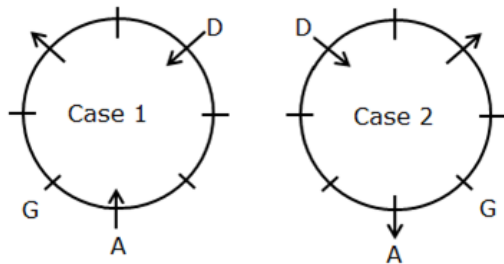

2. E sits second to the left of D. C sits to the immediate right of E.

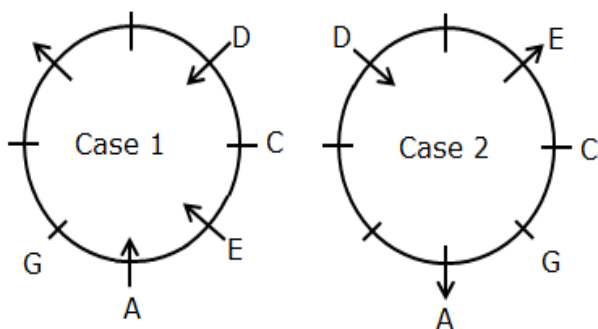

3. H sits beside F, who sits third to the left of C who faces towards the centre. Hence, case 1 gets eliminated.

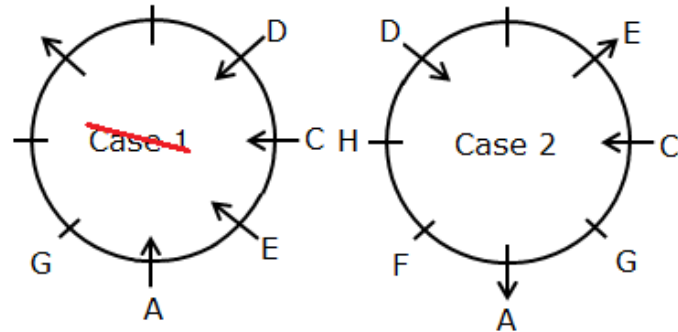

4. H doesn't sit second to the right of B, but both face the same direction. F faces the opposite direction to that of G.

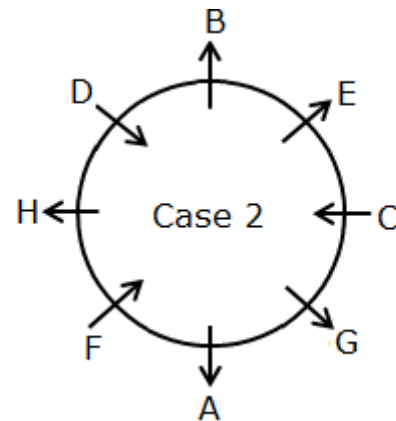

- 241) Answer: C
- 242) Answer: B
- 243) Answer: D
- 244) Answer: A
- 245) Answer: B

Direction (246-250): Answer the questions based on the information given below.

Certain numbers of floors are there in the building in which some floors are occupied by some persons. The lowermost floor is numbered as 1 and the floor immediately above is numbered as 2 and so on. Not more than one person lives on the floor and there is a prime number of floors.

Top Expected Puzzle and Seating Questions for Upcoming Bank Prelims Exams 2021 (English Version)

Both T and P live in the even numbered floor below O, who lives on the 6th floor. Only four floors are there between O and M who doesn't live on the bottom-most floor. R lives six floors above P and seven floors below S. Q lives on the floor immediately below S and three floors below N. The number of floors between R and M is one more than the number of floors between O and T. No floors are there above N.

246. How many floors are there in the building?

- A. 17
- B. 19
- C. 23
- D. 13
- E. None of these

247. Who among the following lives two floors above T?

- A. R
- B. M
- C. O
- D. P
- E. S

248. How many floors are there between Q and M?

- A. 1
- B. 2
- C. 3
- D. More than three
- E. None

249. In which of the following floor does P lives?

- A. 6th
- B. 4th
- C. 8th
- D. 2nd
- E. Cannot be determined

250. As many floors are below T as above ____.

- A. S
- B. N
- C. M
- D. P
- E. Q

Explanation

Floors	Persons
17	N
16	
15	S
14	Q
13	
12	
11	M
10	
9	
8	R
7	
6	O
5	
4	T
3	
2	P
1	

Top Expected Puzzle and Seating Questions for Upcoming Bank Prelims Exams 2021 (English Version)

1. Both T and P live in the even numbered floor below O, who lives on the 6th. Only four floors are there between O and M who doesn't live on the bottom-most floor.

	Case 1	Case 2
Floors	Persons	Persons
11	M	M
10		
9		
8		
7		
6	O	O
5		
4	P	T
3		
2	T	P
1		

2. R lives six floors above P and seven floors below S. Q lives on the floor immediately below S and three floors below N.

	Case 1	Case 2
Floors	Persons	Persons
19	N	
18		
17	S	N
16	Q	
15		S
14		Q
13		
12		
11	M	M
10	R	
9		
8		R
7		
6	O	O
5		
4	P	T
3		
2	T	P
1		

3. The number of floors between R and M is one more than the number of floors between O and T. No floors are there above N. Hence, case 1 gets eliminated.

Top Expected Puzzle and Seating Questions for Upcoming Bank Prelims Exams 2021
(English Version)

 **guidely**

Special Bundle PDF Course for SBI Clerk & IBPS RRB PO Mains Exams 2021

Course Duration: **50 days**

No. of Ques: **5000**



~~₹799~~

₹399

Buy Now



Language:
English & Hindi



Exact Exam Level
Questions



Purely Based on Exact
Exam Level & New Pattern



Answer key with
Video Solution

Grand Bundle PDF Course 2021

Exams Covered:

**SBI Clerk | SBI PO | IBPS RRB PO |
IBPS RRB Clerk | IBPS PO | IBPS Clerk**

Seperate PDF Course for All Major Bank pre + Mains Exams

- Total No. of Ques: **40,000+**
- Question in Bilingual (Eng & Hindi)
- Answers With Detailed **Video Solution**
- Provides you **50 days Study Planner** for each exams
- **Covers All Types** of Questions in Each Topic
- Questions in **Exact Exam Level**
- All Our PDFs are **Downloadable**
- **100% Satisfaction** Assured & It's Worthy for your money
- Download as PDF & also take **Quiz with Timer**

 **guidely**

Grab It Now